

BY LIGHT4

ml

TWENTY_ELEVEN

THE STATE OF LIGHT

MATERIA E LUCE. NUOVE VISIONI, IDEE DI DESIGN CON CUI ESPLORARE L'AMBIENTE CONTEMPORANEO.

MATERIALS AND LIGHT. NEW PERSPECTIVES AND DESIGN IDEAS FOR EXPLORING CONTEMPORARY INTERIORS.



IN VIAGGIO TRA NUOVI SCENARI:

A JOURNEY THROUGH NEW SCENARIOS: LIGHTING REVEALS AN AWARENESS OF SPACE, TACTILE SENSATIONS AND REFLECTED SOUNDS.

**ILLUMINAZIONE COME CONOSCENZA DELLO SPAZIO,
EMOZIONE TATTILE E SUONO RIFLESSO.**



LAMPADINE / BULBS

9W E14					
11W E14					
40W E14		➔	28W E14		ENERGY SAVER
60W E14		➔	42W E14		ENERGY SAVER
40W E14		➔	28W E14		ENERGY SAVER
60W E14		➔	42W E14		ENERGY SAVER
14W E27					
15W E27					
20W E27					
23W E27					
30W E27					
60W E27		➔	42W E27		ENERGY SAVER
60W E27		➔	42W E27		ENERGY SAVER
75W E27		➔	52W E27		ENERGY SAVER
100W E27		➔	70W E27		ENERGY SAVER
150W E27		➔	100W E27		ENERGY SAVER
13W G24q-1					
26W G24q-3					
40W G9		➔	33W G9		ENERGY SAVER
60W G9		➔	48W G9		ENERGY SAVER
75W G9		➔	60W G9		ENERGY SAVER
150W R7s 80mm		➔	100W R7s 80 mm		ENERGY SAVER
150W R7s 114mm		➔	120W R7s 114mm		ENERGY SAVER
200W R7s 114mm		➔	160W R7s 114mm		ENERGY SAVER
300W R7s 114mm		➔	230W R7s 114mm		ENERGY SAVER

INDICE INDEX

ANGEL	195
AL	027
ALIAS	229
BIG	187
B.O.X.	031
CANDIDA	239
CANDY	077
CHARME	051
CLIP	133
CUBE	121
QB	126
DOUBLE	221
DROP	179
ELLE	041
FADE	209
FIODOR	009
HANG	047
MLAMP SHADES	137
MAX	191
MISTRAL	163
NET	173
ONDA	193
OVO	243
PASHÀ	201
PLANA	105
SILHOUETTE	055
SQUARE	097
STAR	085
TULIP	117

**FIODOR**design **Diego Chilò**

Lampada modulare con diffusori in vetro soffiato opalino satinato. Particolare di fissaggio in alluminio tornito e lucidato.

A modular lamp with opal white blown glass diffusers with satin finish. A detail of a polished lathe-turned aluminium fitting.

AP/ PL ZERO

1 x max 60W E27 inc
 1 x max 23W E27 fluor or
 1 x max 18W G24 q-2 fluor



012



013

ML FIODOR



014

015

ML FIODOR



FIODOR

design **Diego Chilo**

AP/ PL 3

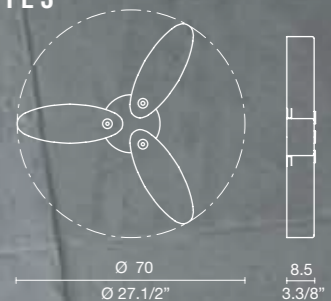

3 x max 60W E27 inc
 3 x max 23W E27 fluor or
 3 x max 18W G24 q-2 fluor

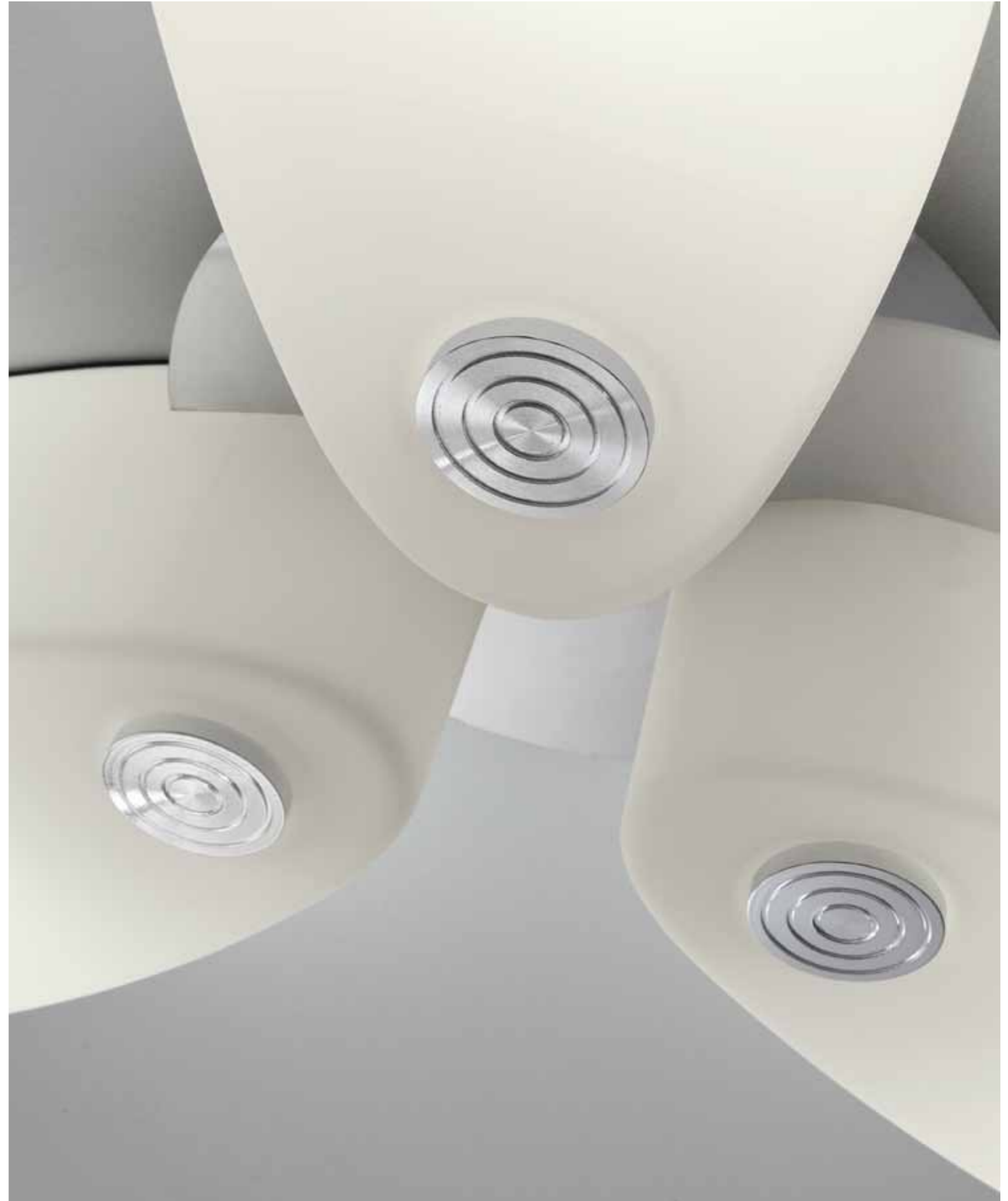

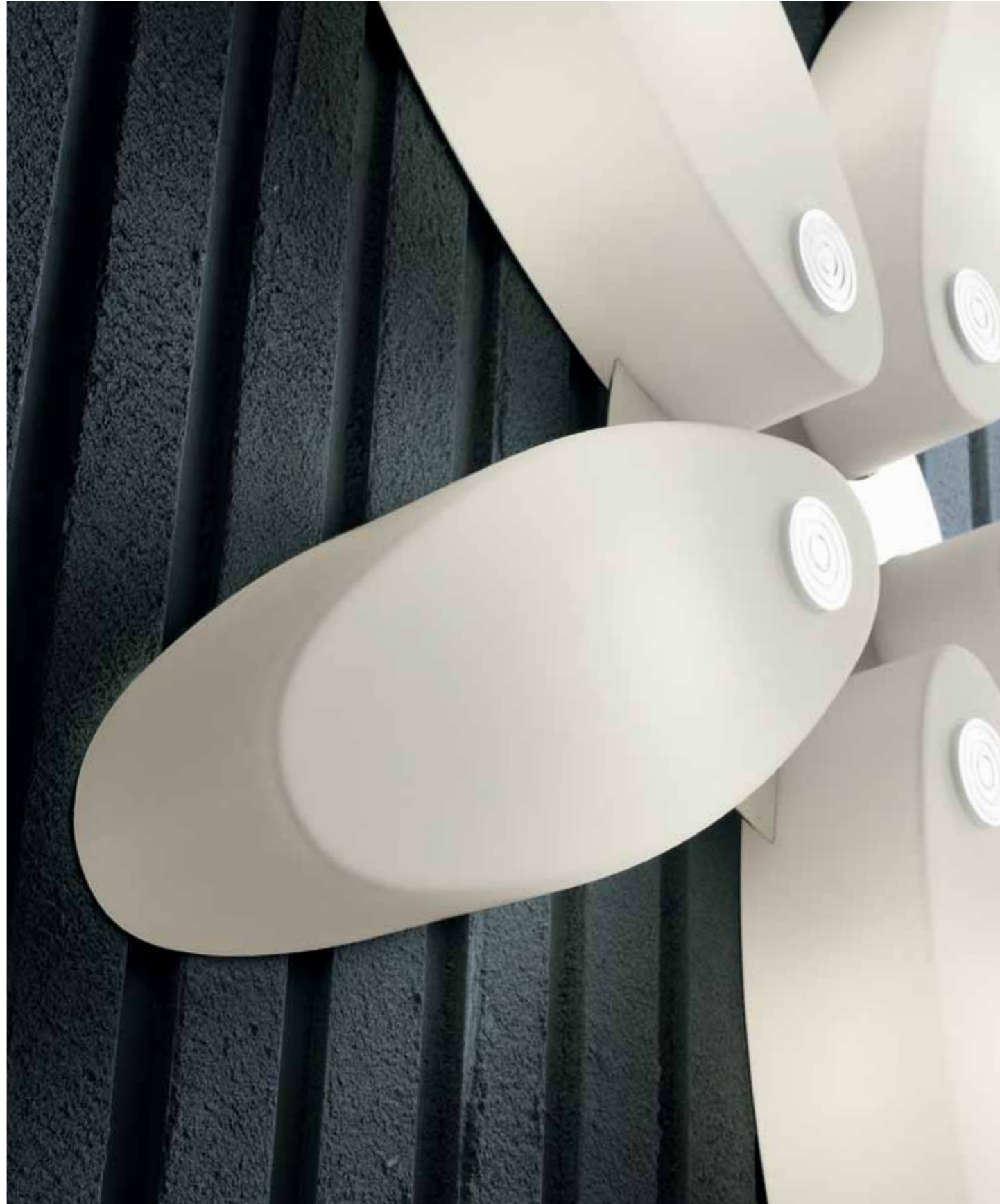

FIODOR

design **Diego Chilò**

AP/ PL 5

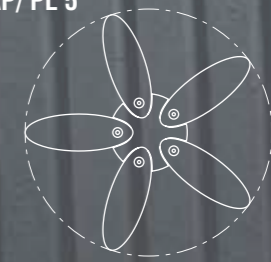

Ø 76
Ø 29.7/8"

8.5
3.3/8"

5 x max 60W E27 inc
5 x max 23W E27 fluor or
5 x max 18W G24 q-2 fluor

020



021

MLFIODOR



022



023



MLFIODOR

FIODOR

design **Diego Chilo**

AP/ PL 1

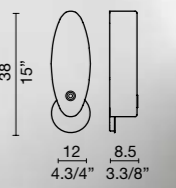

1 x max 60W E27 inc
1 x max 23W E27 fluor or
1 x max 18W G24 q-2 fluor

MODULO SERIALE, FANTASIA. CEMENTO E NATURA, OGGETTO E LUCE. MENTE E VISIONE. SCENARI INNOVATIVI ED ESPLORAZIONI
PROGETTUALI PER UN AMBIENTE INEDITO, FRUTTO DI INCONTRI ARTIFICIALI, DOVE LA LUCE REGNA SOVRANA.

A SEQUENTIAL ELEMENT AND FANTASY. CEMENT AND
NATURE, OBJECTS AND LIGHT. MIND AND PERSPECTIVE.
INNOVATIVE SCENARIOS AND EXPLORATORY DESIGNS
PROVIDE A NEW INTERIOR, THE OUTCOME OF MAN-MADE
COMBINATIONS, WHERE LIGHT REIGNS SUPREME.

026



027

MLAL

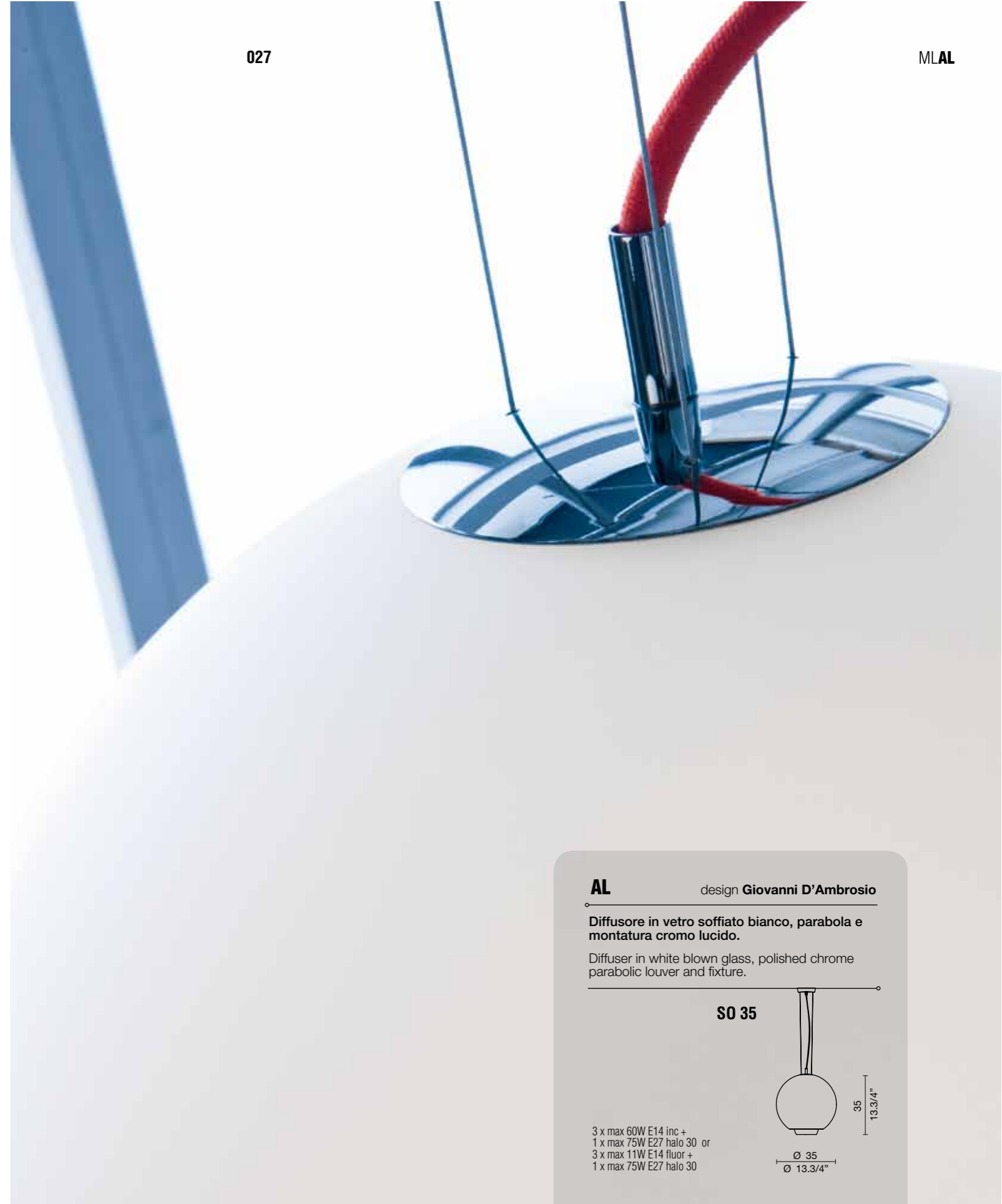

AL design **Giovanni D'Ambrosio**

Diffusore in vetro soffiato bianco, parabola e montatura cromo lucido.

Diffuser in white blown glass, polished chrome parabolic louver and fixture.

S0 35

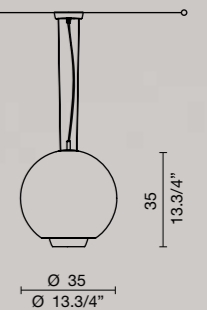

3 x max 60W E14 inc +
1 x max 75W E27 halo 30 or
3 x max 11W E14 fluor +
1 x max 75W E27 halo 30



AL design **Giovanni D'Ambrosio**

PL45



PL 60



3 x max 60W E27 inc +
1 x max 75W E27 halo 30 or
3 x max 15W E27 fluor +
1 x max 75W E27 halo 30

3 x max 75W E27 inc +
1 x max 75W E27 halo 30 or
3 x max 15W E27 inc +
1 x max 75W E27 halo 30

**BOX**design **Mauro Marzollo****AP/PL 20**

1 x max 150W R7s 80 mm halo
1 x max 13W G24q-1 fluor



20
7.7/8"

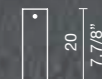

7
2.3/4"

20
7.7/8"

AP/PL 65

65
25.5/8"



7
2.3/4"

20
7.7/8"

2 x max 150W R7s 114 mm halo
1 x max 55W 2G11 fluor

**BOX**design **Mauro Marzollo**

Vetro diffusore con finitura a specchio.
Montatura acciaio lucido.

Glass diffuser with mirror finish.
Polished steel fixture.

CO

1 x max 60W E14 inc
1 x max 9W E14 fluor

20 7
7.7/8" 2.3/4"





BOX design **Mauro Marzollo**

TA 30

30 11.3/4" 7 2.3/4" 34 13.3/8"

1 x max 100W E27 inc
1 x max 14W E27 fluor

TA 65

65 25.5/8" 7 2.3/4" 24 9.1/2"

2 x max 100W E27 inc
2 x max 14W E27 fluor

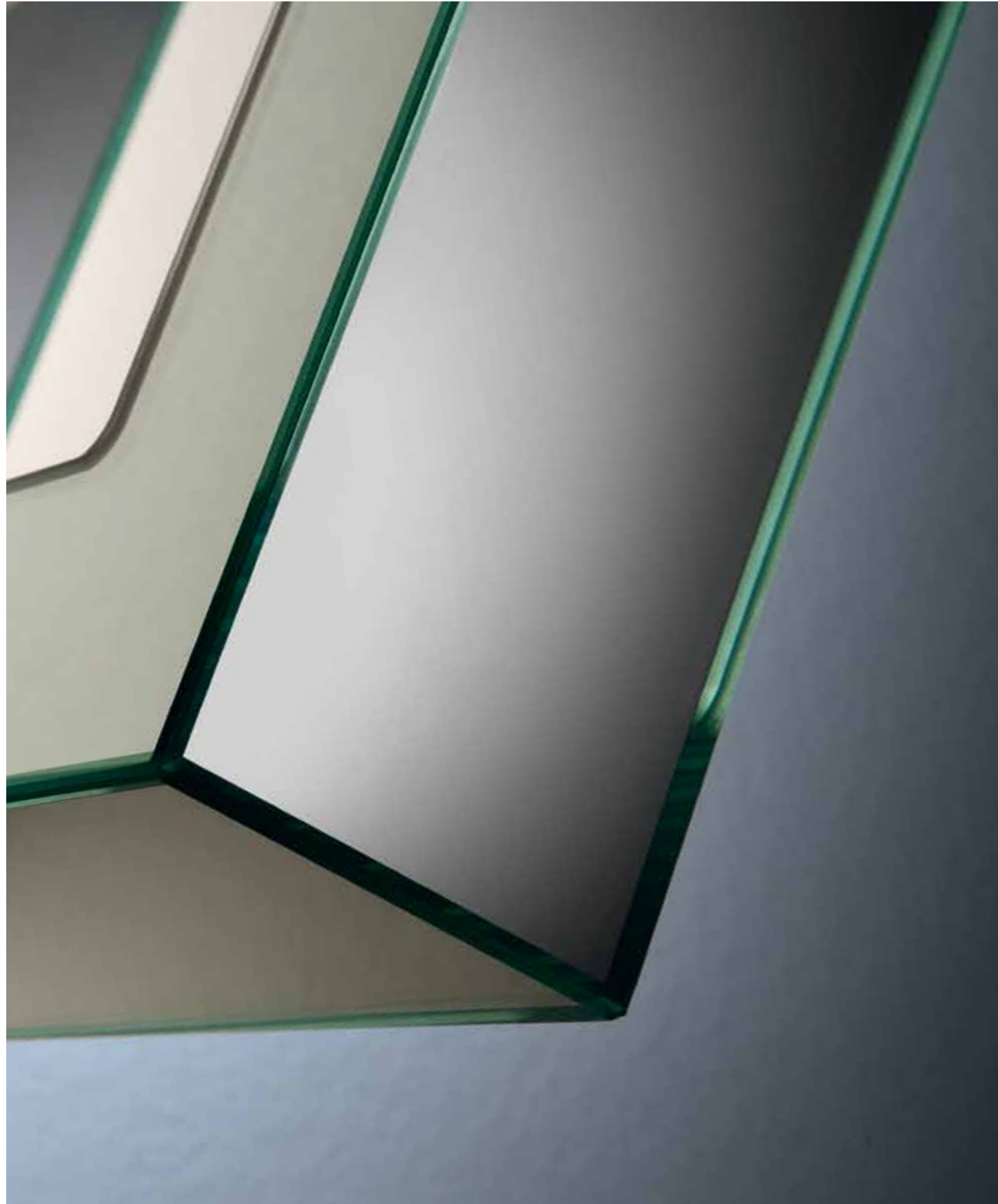

BOX design Mauro Marzollo

AP/PL 30

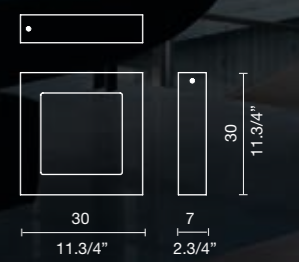

1 x max 200W R7s 114 mm halo
1 x max 26W G24q-3 fluor

**ELLE**design **L4B**

Diffusore in vetro soffiato incamiciato bianco trattato con satinatura interna ed esterna. Montatura acciaio satinato.

'Incamiciato' blown glass diffuser in the following white with satin finish on the inside and outside. Mounting: satin-finish steel.

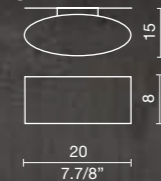
AP 20

1 x max 150W R7s 80 mm halo

AP 33

1 x max 200W R7s 114 mm halo

042



043



MELLE



CHIAROSCURO, STRUTTURE IMPALPABILI, FORME PURE ILLUMINATE DALLA RICERCA DI NUOVI LINGUAGGI. LINEE ED ESPRESSIONI CHE CAMBIANO, EVOLUZIONE DI MESSAGGI E CODICI: LA LUCE PLASMA LA MODERNITÀ.

CHIAROSCURO EFFECTS, INTANGIBLE STRUCTURES AND ELEGANT SHAPES ILLUMINATED

IN THE PURSUIT OF NEW APPEAL LINES AND EXPRESSIONS TRANSFORM, MESSAGES AND CODES ARE DEVELOPED: LIGHT GIVES SHAPE TO MODERN STYLE.

HANGdesign **L4B**

Diffusore in vetro soffiato bianco satinato.
Montatura in acciaio lucido.

Diffuser in satin white blown glass.
Polished steel fixture.

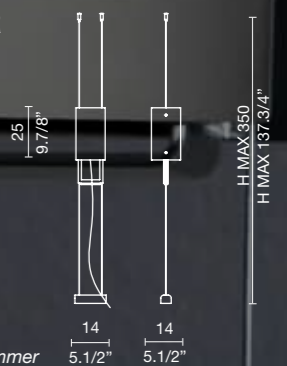
TR

1 x max 150W E27 inc
1 x max 250W E27 halo
con dimmer / with dimmer

048



049

MLHANG



HANG

design **L4B**

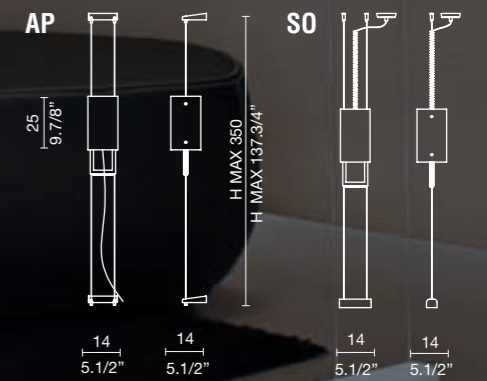

1 x max 150W E27 inc
1 x max 250W E27 halo
con dimmer / with dimmer

1 x max 150W E27 inc
1 x max 250W E27 halo
1 x max 23W E27 fluor

**CHARME**design **L4B**

Lampada di grande diametro in vetro soffiato incamiciato bianco o nero lucido. Montatura bianca opaca laccata.

Large-diameter lamp in blown glass cased in white or glossy black. White opaque enamelled base.

SO 32

1 x max 150W E27 inc
1 x max 20W E27 fluor

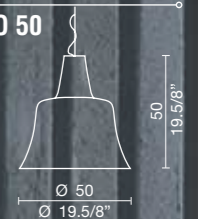
SO 50

3 x max 40W E14 inc +
1 x max 150W E27
3 x max 11W E14 fluor +
1 x max 23W E27 fluor







058



059

ML SILHOUETTE

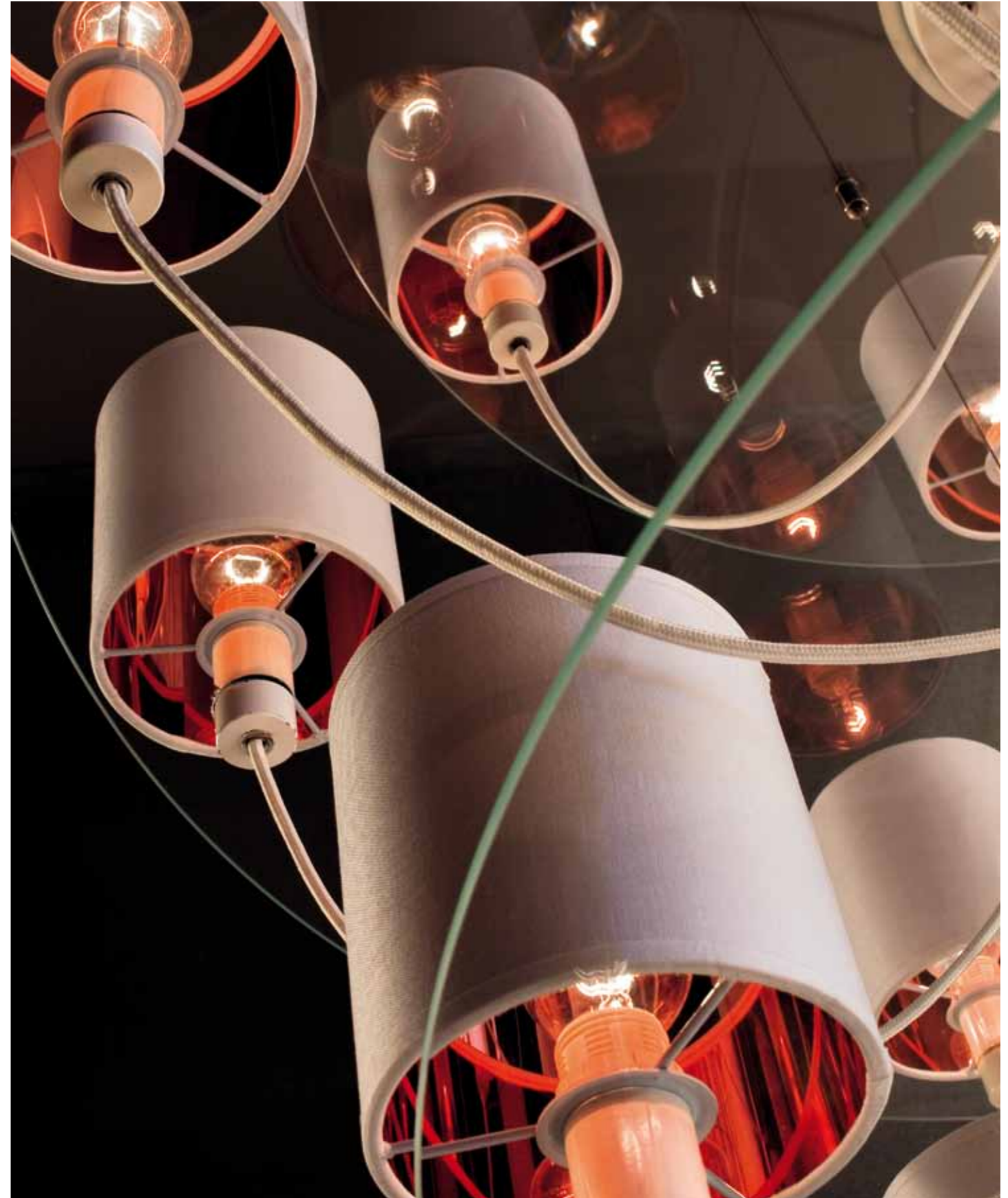

060

061

ML SILHOUETTE



062



063

ML SILHOUETTE







068



069

ML SILHOUETTE



070



071



ML SILHOUETTE

SILHOUETTE COLLECTIONdesign **Mauro Marzollo**

Lampadario modulare con struttura in vetro lastra.
Diffusori in tessuto in diverse finiture.
Cavi d'alimentazione con rivestimento in cotone.

A modular lamp with a plate glass structure.
Diffusers in fabric with a variety of finishes
Power cables faced with cotton.

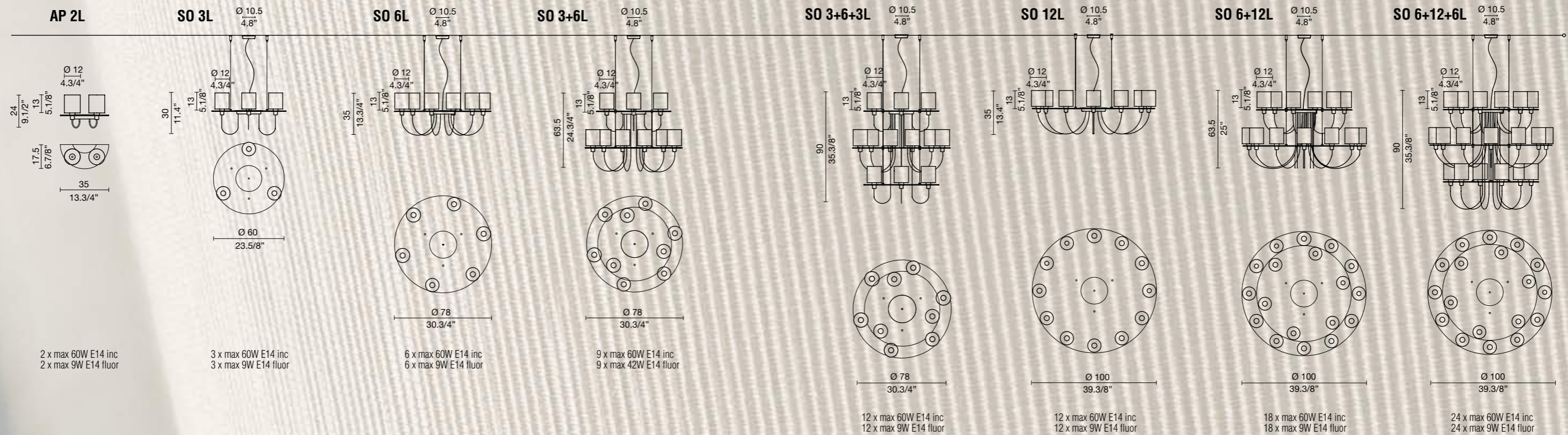

**POST MODERNO E POST INDUSTRIALE, PENSIERO LIBERO:
REALTÀ. PROIETTATI VERSO IL FUTURO PER COSTRUIRE**

**DALL'IDEA AL PROGETTO FINO ALL'INCONTRO CON LA
NUOVI SPAZI E SPRIGIONARE L'ENERGIA DELLA LUCE.**

POST-MODERN, POST-INDUSTRIAL AND FREETHINKING: AN IDEA LEADS
TO A DESIGN PROJECT, AND THEN A TANGIBLE PRODUCT. FOCUSING ON
THE FUTURE TO CREATE NEW SPACES AND RELEASE ENERGY FROM LIGHT.



**CANDY**

Archivio Storico

doppia accensione / double switch

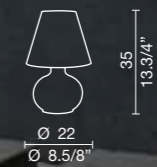
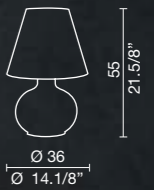
TA 351 x max 60W E14 inc +
1 x max 40W E14 inc**TA 55**1 x max 100W E27 inc +
2 x max 40W E14 inc**TA 75**1 x max 150W E27 inc +
2 x max 60W E14 inc

**CANDY**

Archivio Storico

Diffusore in vetro soffiato bianco satinato con montatura bianco opaco.

Blown glass diffuser white satin-finish with mat-white mounting.

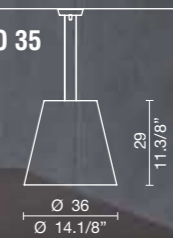
SO 35

1 x max 150W E27 inc
1 x max 23W E27 fluor

SO 45

3 x max 100W E27 inc
3 x max 23W E27 fluor

080



081

MLCANDY



**CANDY**

Archivio Storico

doppia accensione / double switch

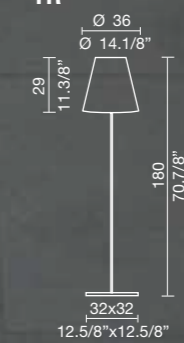
TR

1 x max 150W E27 inc or
 1 x max 250W E27 halo

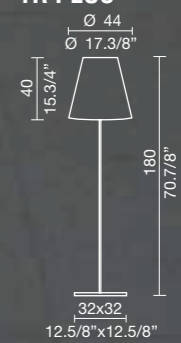
TR PLUS

3 x max 60W E14 inc +
 1 x max 250W E27 halo

**STAR**

Archivio Storico

Diffusore in vetro soffiato satinato bianco, cornice in wengé, in acciaio e in vetro colorato. Montatura laccata bianco.

White satin-finish blown glass diffuser; squared blackplate in wengé, steel and glass colored. Mounting: white enamelled finish.

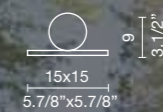
CO

1 x max 40W G9 halo

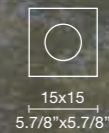
AP/PL 15profondità 10
depth 4"

1 x max 40W G9 halo

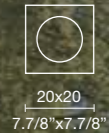
AP/PL 20profondità 6
depth 2.3/8"

1 x max 40W G9 halo

AP/PL 30profondità 7,5
depth 2.7/8"

1 x max 60W E14 inc

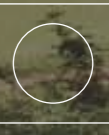
AP/PL 40profondità 11
depth 4.3/8"2 x max 60W E27 inc
2 x max 14W E27 fluor**AP/PL 52**profondità 13
depth 5.1/8"2 x max 75W E27 inc
2 x max 20W E27 fluor**AP/PL 62**profondità 13
depth 5.1/8"2 x max 75W E27 inc
2 x max 20W E27 fluor









STARCOLOURS

			
FOGLIA ORO GOLD LEAF	FOGLIA ARGENTO SILVER LEAF	ACCIAIO STEEL	CRISTALLO SATINATO SATIN FINISH CRYSTAL
			
SPECCHIO MIRROR FINISH	WENGÉ WENGÉ	FUXIA FUXIA	NERO BLACK
			
BLU BLUE	ROSSO RED	ARANCIO ORANGE	VERDE GREEN



SQUARECOLOURS

			
FOGLIA ORO GOLD LEAF	FOGLIA ARGENTO SILVER LEAF	ACCIAIO STEEL	CRISTALLO SATINATO SATIN FINISH CRYSTAL
			
SPECCHIO MIRROR FINISH	WENGÉ WENGÉ	FUXIA FUXIA	NERO BLACK
			
BLU BLUE	ROSSO RED	ARANCIO ORANGE	VERDE GREEN

SQUARE

Archivio Storico

Diffusore in vetro soffiato satinato bianco, cornice in wengé, in acciaio e in vetro colorato. Montatura laccata bianco.

White satin-finish blown glass diffuser; squared blackplate in wengé, steel and glass colored. Mounting: white enamelled finish.

AP/PL 25



25x25
9.7/8"x9.7/8"

profondità 6,5
depth 2.1/2"

1 x max 40W G9 halo

AP/PL 35



35x35
13.3/4"x13.3/4"

profondità 7
depth 2.3/4"

1 x max 60W E14 inc

AP/PL 45

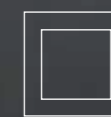

45x45
17.3/4"x17.3/4"

profondità 7
depth 2.3/4"

2 x max 60W E14 inc

AP/PL 55



55x55
21.5/8"x21.5/8"

profondità 8
depth 3.1/8"

2 x max 60W E14 inc

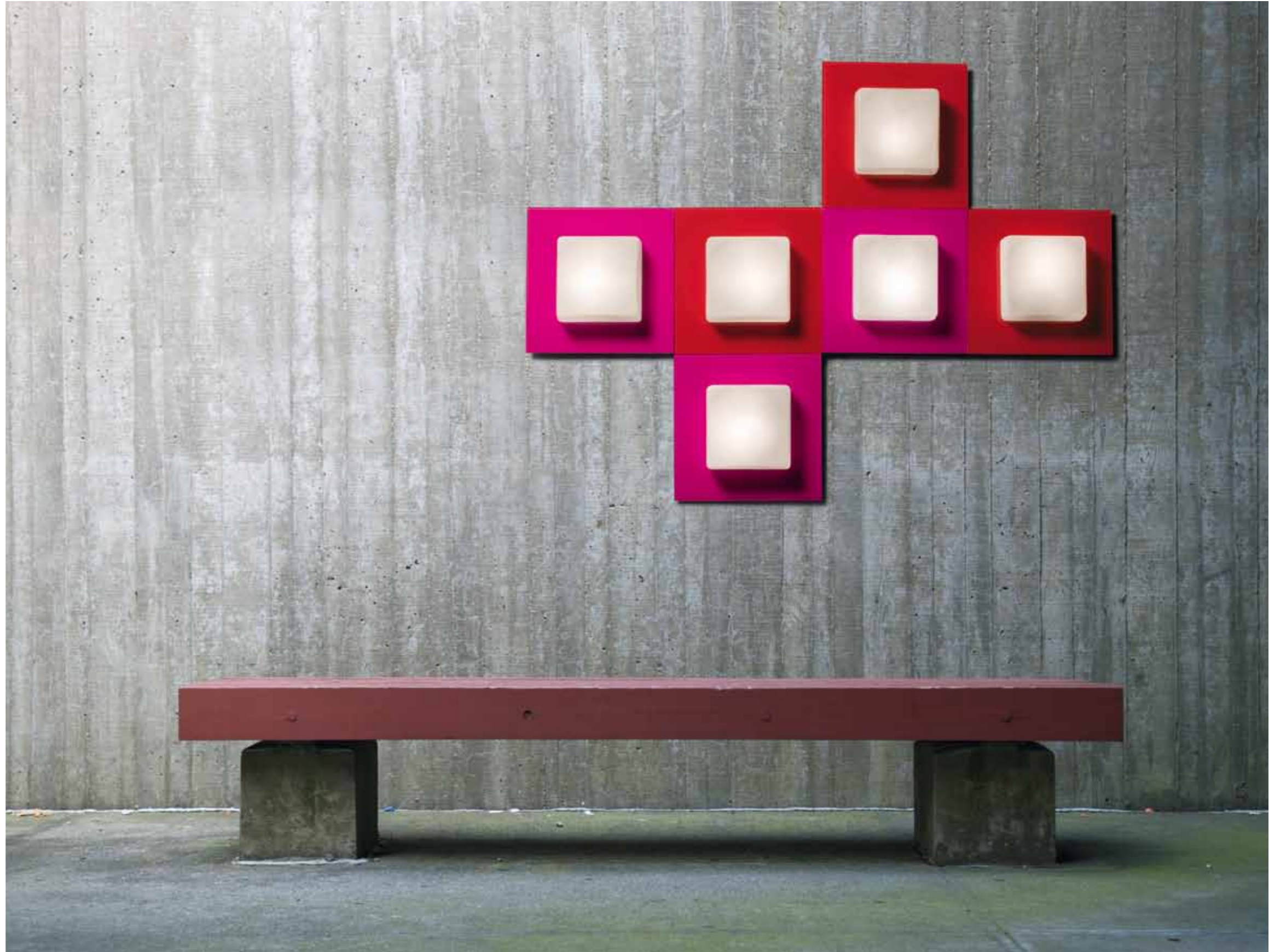

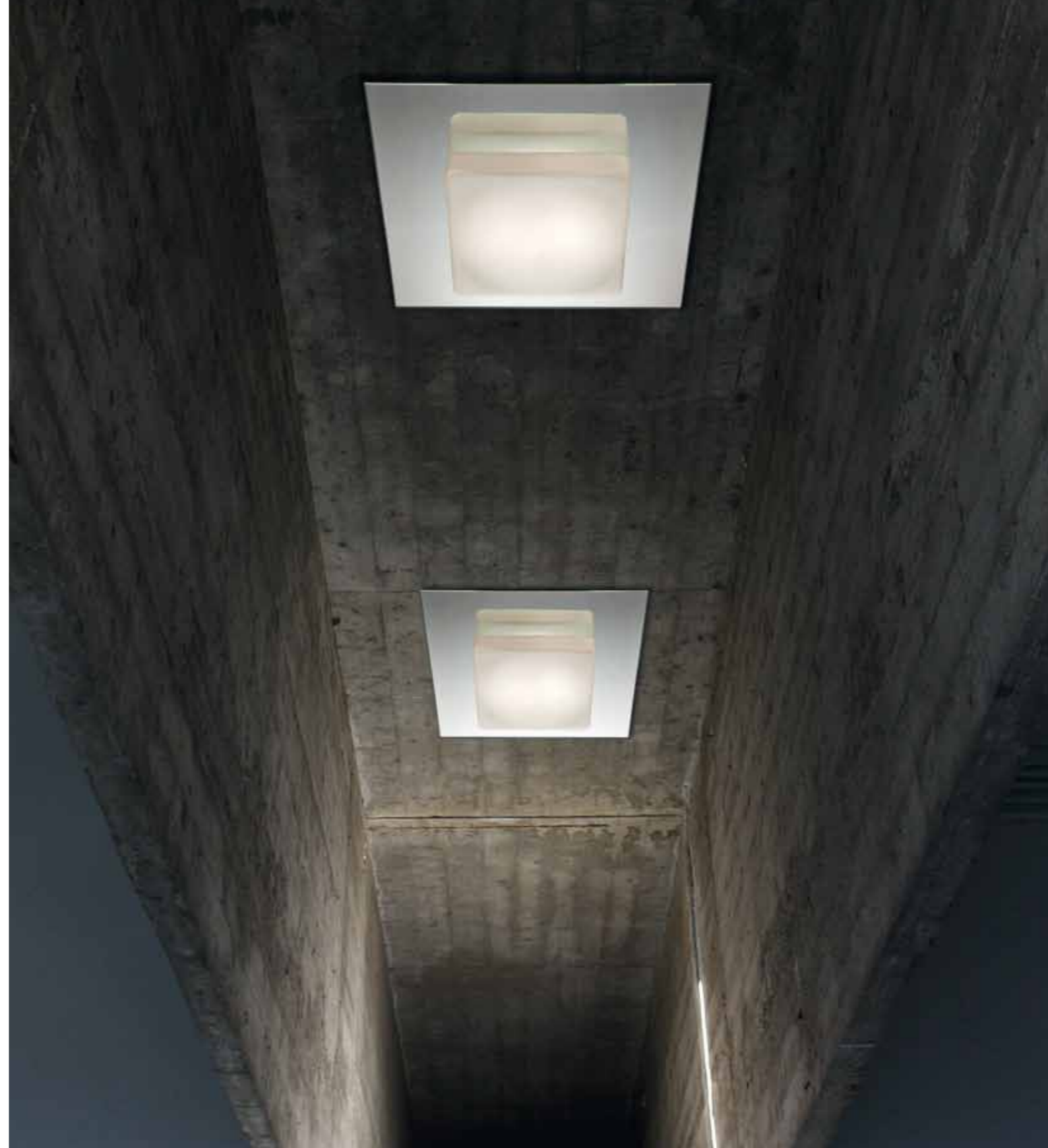

**LA SUPERFICIE CAMBIA IDENTITÀ,
SOLCATA DA VENATURE E OMBRE:
LA LUCE DISEGNA SPAZI, CREA
DETTAGLI INVISIBILI.**

**ELEMENTO MICROSCOPICO IN MOTO
ONDULATORIO, VITALE ED INFINITO:
DOMABILE SOLO DALLA FORZA
DELLE IDEE.**

**CROSSED BY GRAINS
AND SHADOWS,
SURFACES CHANGE
IDENTITY: LIGHT
DELINEATES SPACES,
CREATING INVISIBLE
DETAILS.**

**A MICROSCOPIC
ELEMENT WITH A
VITAL AND INFINITE
WAVE MOTION:
ONLY CONTROLLED
BY THE POWER OF
IDEAS.**



PLANA

design **Mauro Marzollo**

SO 45



1 X max 150W E27 inc
 1 X max 105W E27 halo
 1 X max 20W E27 fluor

SO 65

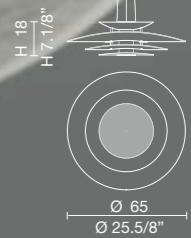

1 X max 250W E27 halo
 1 X max 150W E27 inc
 1 X max 23W E27 fluor

SO 45PLUS



1 X max 150W E27 inc
 1 X max 105W E27 halo
 1 X max 20W E27 fluor

SO 65PLUS

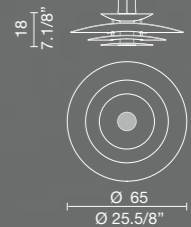

1 X max 250W E27 halo
 1 X max 150W E27 inc
 1 X max 23W E27 fluor

**PLANA**design **Mauro Marzollo**

Diffusore in vetro termocurvato nei colori:
foglia oro, foglia argento, bianco lucido.
Montatura laccata bianco.

Heat-bent glass diffuser in the following colours:
gold leaf, silver leaf and gloss white.
White lacquer fixture.

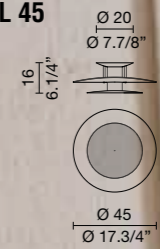
PL 45

1 x max 150W E27 inc
1 x max 105W E27 halo
1 x max 20W E27 fluor

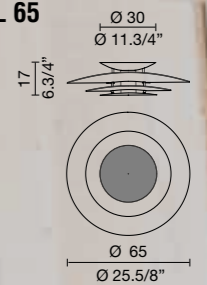
PL 65

1 X max 250W E27 halo
1 X max 150W E27 inc
1 X max 23W E27 fluor







PLANA design **Mauro Marzollo**

PL 45PLUS	PL 65PLUS
<ul style="list-style-type: none"> 1 x max 150W E27 inc 1 x max 105W E27 halo 1 x max 20W E27 fluor 	<ul style="list-style-type: none"> 1 X max 250W E27 halo 1 X max 150W E27 inc 1 X max 23W E27 fluor



PLANA

design **Mauro Marzollo**

AP

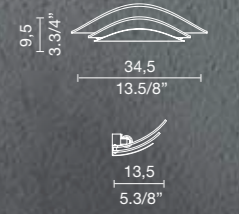

1 X max 160W R7s 114 mm halo

**TULIP**

Archivio Storico

Lastra in vetro termocurvato bianco.
Particolare in cristallo soffiato.
Montatura: nikel satinato.

Curved glass white. Detail in blown glass with
crystal finish. Mounting: nickel-plated with
satin-finish.

S0

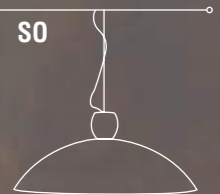

1 x max 100W E27 inc
1 x max 23W E27 fluor

Ø 58
Ø 22.7/8"

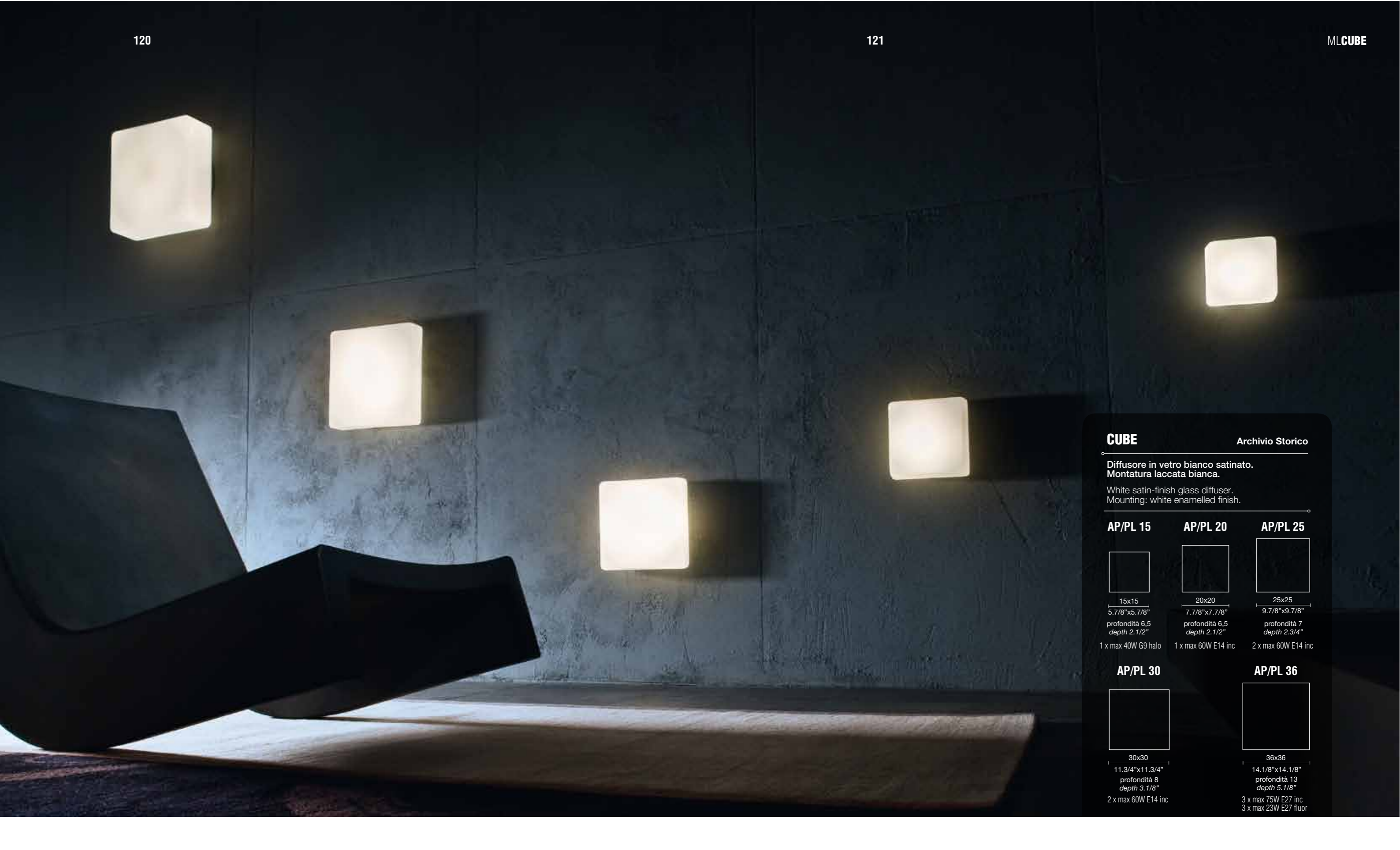

**CUBE**

Archivio Storico

Diffusore in vetro bianco satinato.
Montatura laccata bianca.

White satin-finish glass diffuser.
Mounting: white enamelled finish.

AP/PL 15

15x15
5.7/8"x5.7/8"
profondità 6,5
depth 2.1/2"

1 x max 40W G9 halo

AP/PL 20

20x20
7.7/8"x7.7/8"
profondità 6,5
depth 2.1/2"

1 x max 60W E14 inc

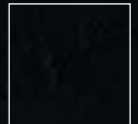
AP/PL 25

25x25
9.7/8"x9.7/8"
profondità 7
depth 2.3/4"

2 x max 60W E14 inc

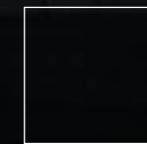
AP/PL 30

30x30
11.3/4"x11.3/4"
profondità 8
depth 3.1/8"

2 x max 60W E14 inc

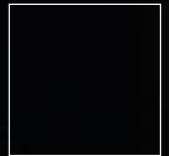
AP/PL 36

36x36
14.1/8"x14.1/8"
profondità 13
depth 5.1/8"

3 x max 75W E27 inc
3 x max 23W E27 fluor



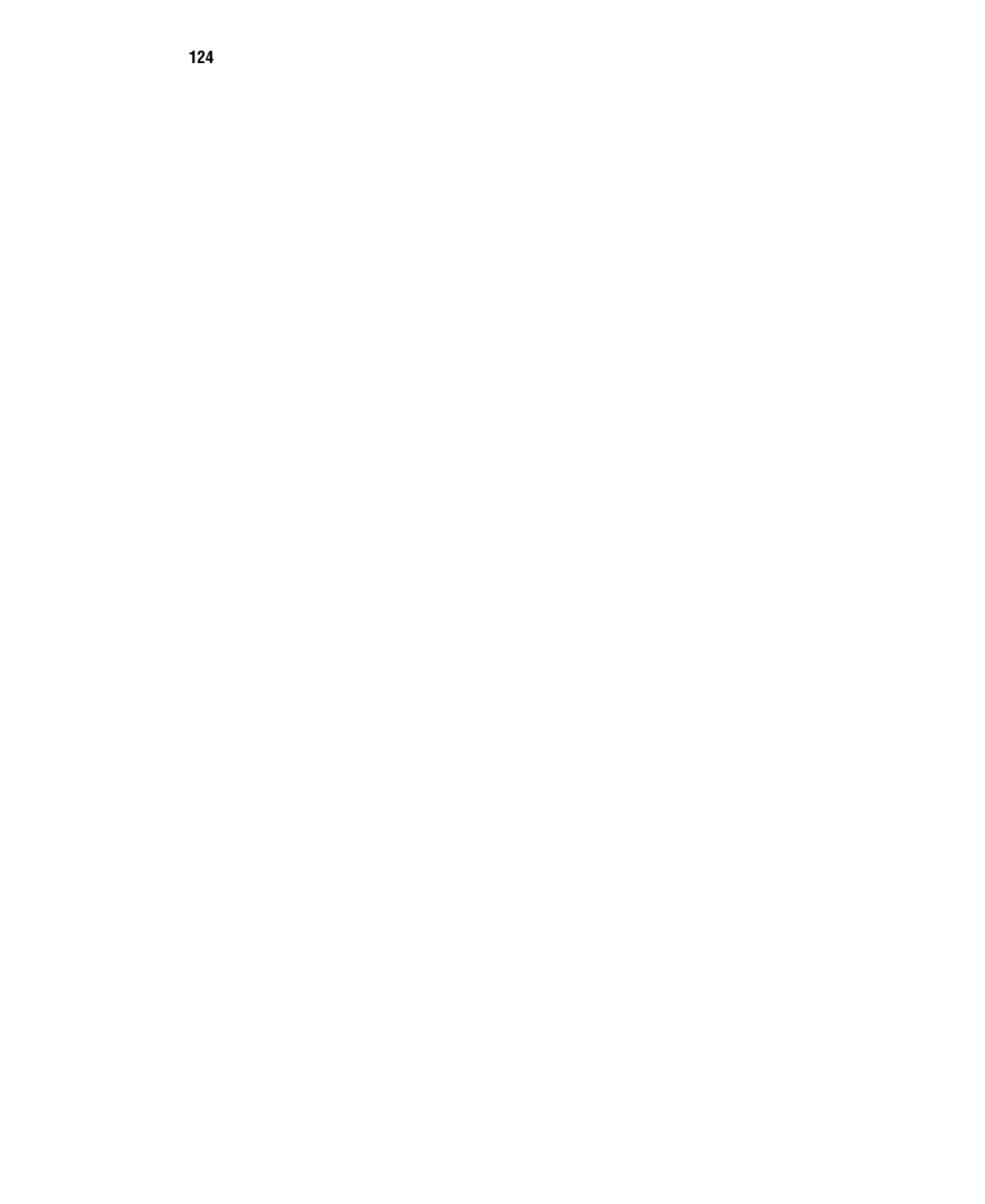



QB design **L4B**

AP/PL 11	AP/PL 16
<p>11x11 4.3/8" x 4.3/8"</p>	<p>16x16 6.1/4" x 6.1/4"</p>
1 x max 40W G9 halo	1 x max 60W G9 halo

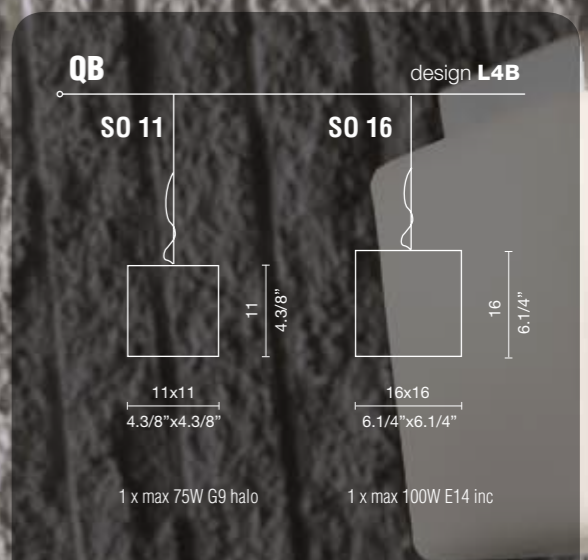



QB design **L4B**

Diffusore in vetro soffiato bianco satinato.
Montatura laccata bianco opaco.

White satin-finish glass diffuser. Mounting: white
enamelled matte finish.

CO 11



11x11
4.3/8"x4.3/8"

1 x max 40W G9 halo

CO 16



16x16
6.1/4"x6.1/4"

1 x max 60W E14 inc

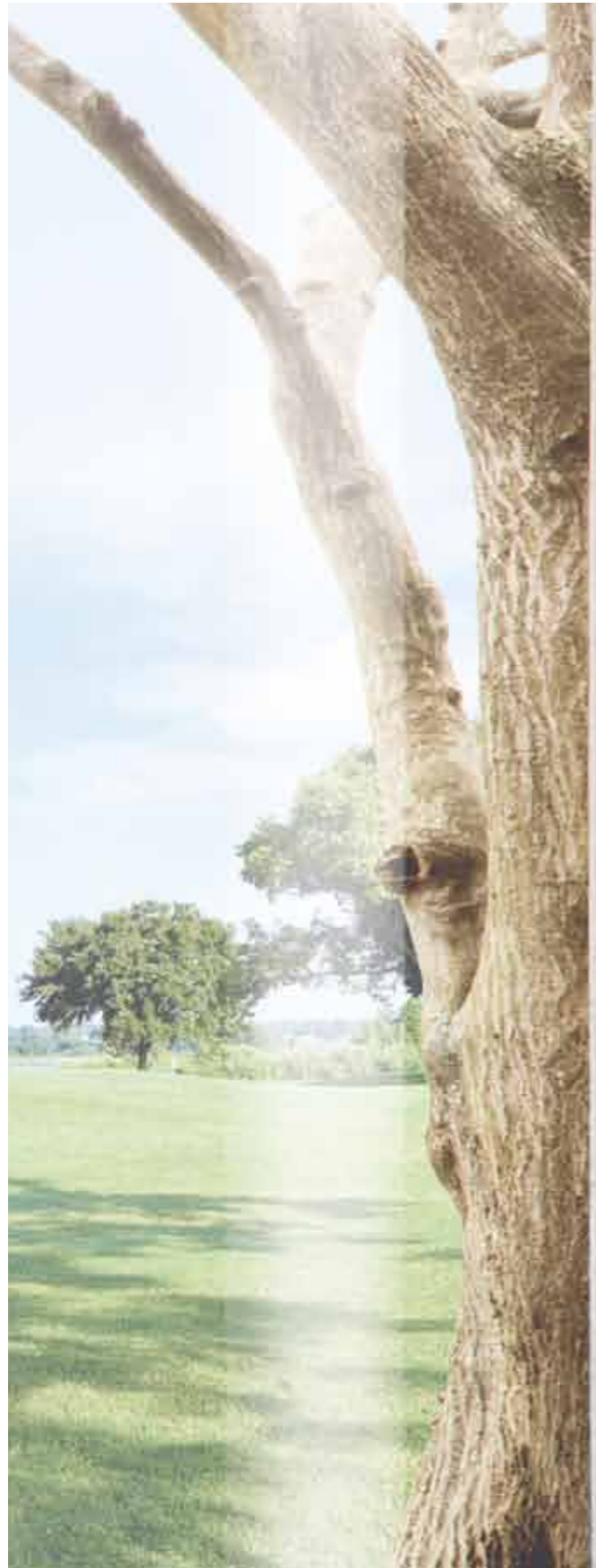
**CLIP**

Archivio Storico

Diffusore in vetro bianco satinato.
Montatura laccata bianca.

White satin-finish glass diffuser.
Mounting: white enameled finish.

AP/PL 13

Ø 13
Ø 5.1/8"

profondità 6
depth 2.3/8"

1 x max 40W G9 halo

AP/PL 20

Ø 20
Ø 7.7/8"

profondità 7,5
depth 2.7/8"

1 x max 60W E14 inc

AP/PL 30

Ø 30
Ø 11.3/4"

profondità 11
depth 4.3/8"

2 x max 60W E27 inc.
2 x max 15W E27 fluor

AP/PL 40

Ø 40
Ø 15.3/4"

profondità 13
depth 5.1/8"

2 x max 75W E27 inc
2 x max 20W E27 fluor

AP/PL 50

Ø 50
Ø 19.5/8"

profondità 15
depth 5.7/8"

3 x max 75W E27 inc
3 x max 20W E27 fluor



BY LIGHT4 mlampshades

MLAMP SHADES COLOURS

				
COD. 01 BIANCO COD. 01 WHITE	COD. 02 ROSSO COD. 02 RED	COD. 03 VERDE COD. 03 GREEN	COD. 04 BLU COD. 04 BLUE	COD. 05 NERO COD. 05 BLACK
				
COD. 06 MARRONE COD. 06 BROWN	COD. 07 AVORIO COD. 07 IVORY	COD. 08 CARBONIO COD. 08 CARBON	COD. 09 TABACCO COD. 09 TOBACCO	COD. 10 CREMA COD. 10 CREME















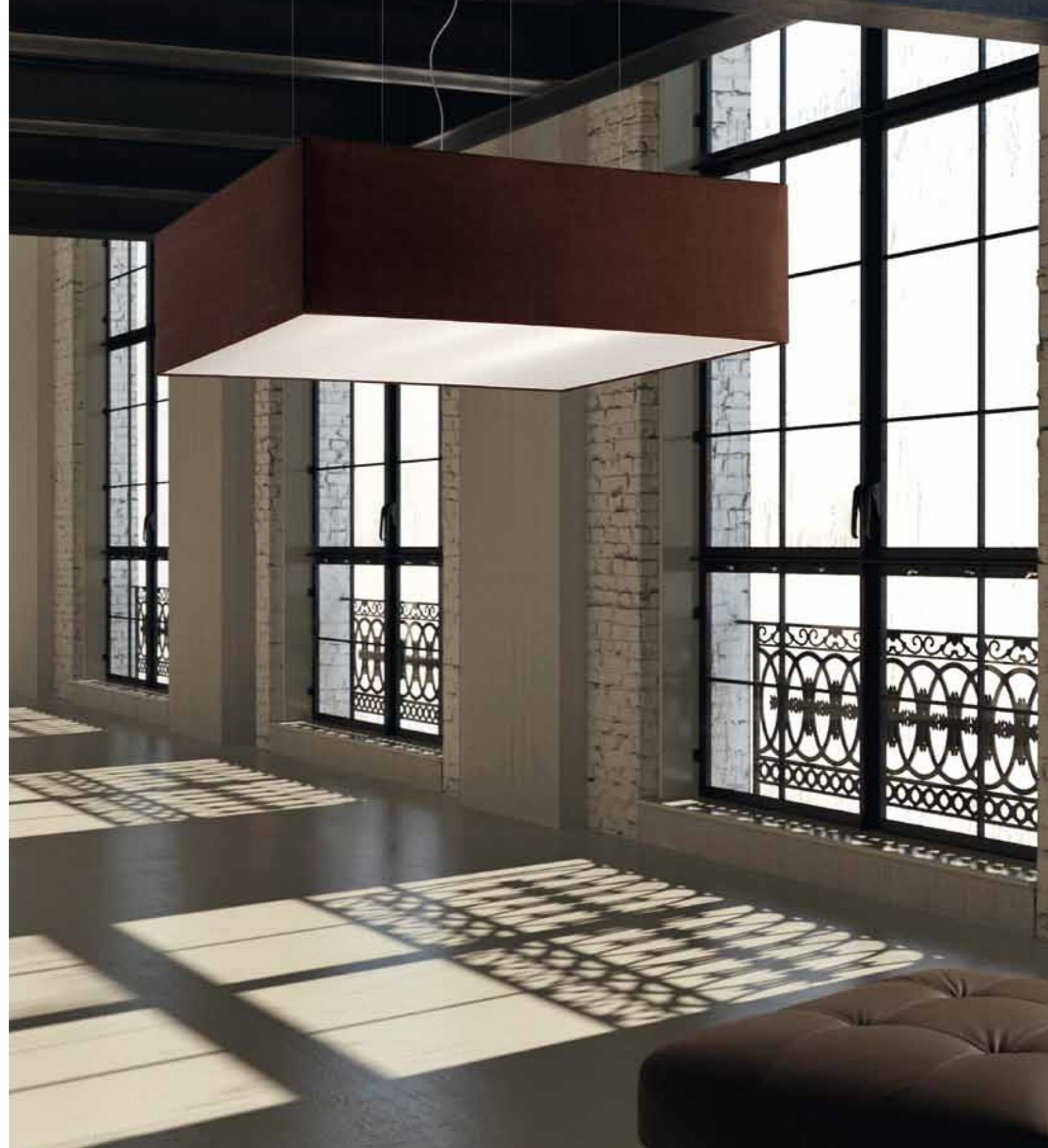









TERRA / FLOOR

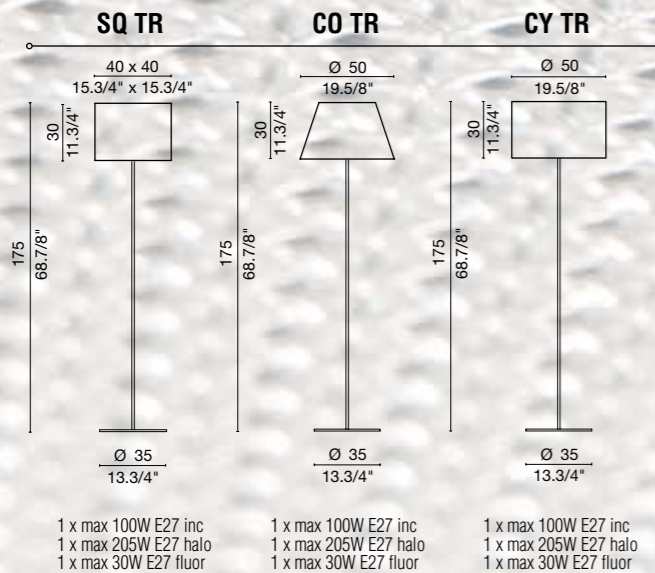

COMODINO E TAVOLO / BEDSIDE & TABLE

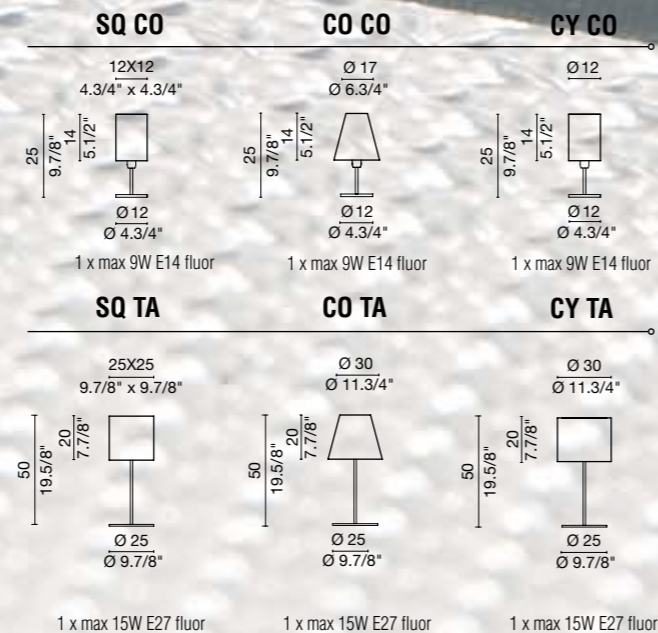

PLAFONE CONO / CEILING CONE

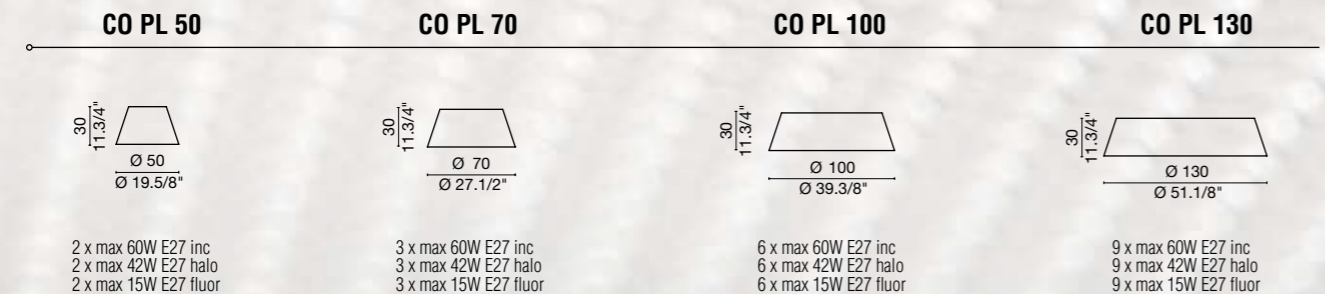

PLAFONE CILINDRO / CEILING CYLINDER

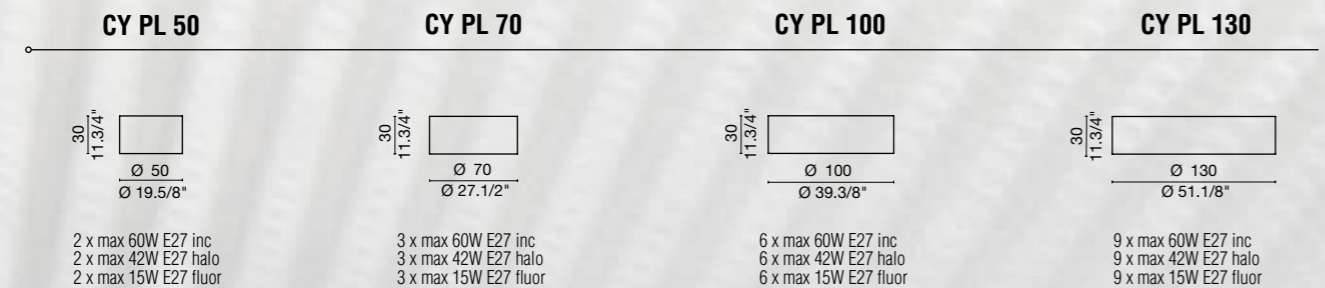

PLAFONE QUADRATO / CEILING SQUARE

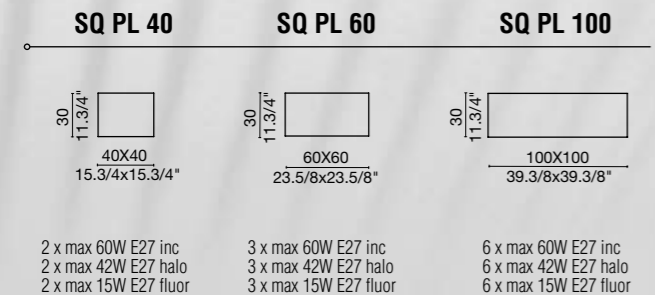

PARETE / WALL

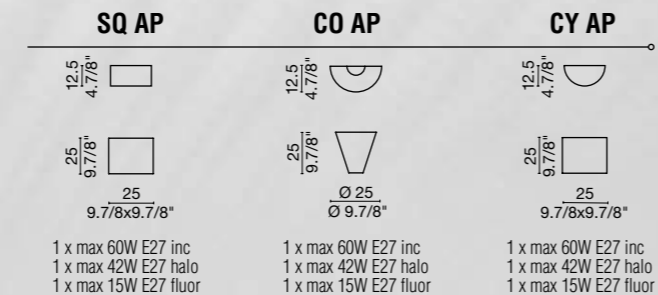

MLAMP SHADES COLLECTION

design L4B

Collezione di paralumi con vari tessuti. Diffusore in metacrilato prismatico. Montature e basi verniciate bianco o grigio arctic.

A collection of lampshades in a variety of fabrics. Prismatic methacrylate diffuser. "White or arctic grey lacquered metal fixtures and base plates".

SOSPENSIONE CONO / SUSPENSION CONE

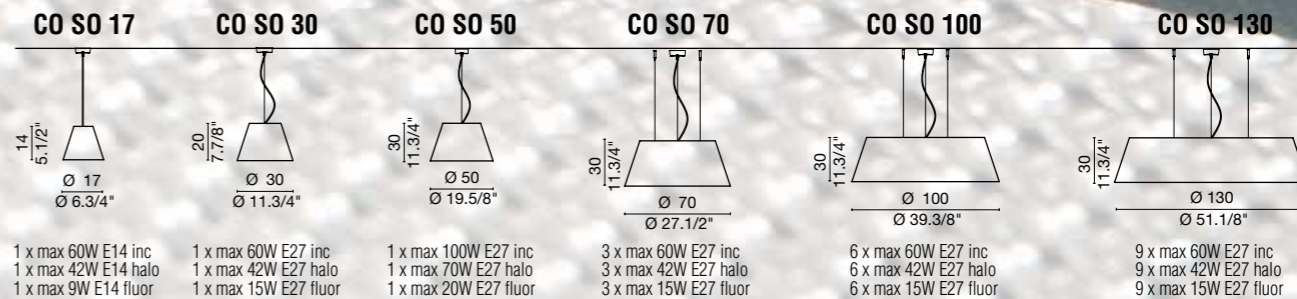

SOSPENSIONE CILINDRO / SUSPENSION CYLINDER

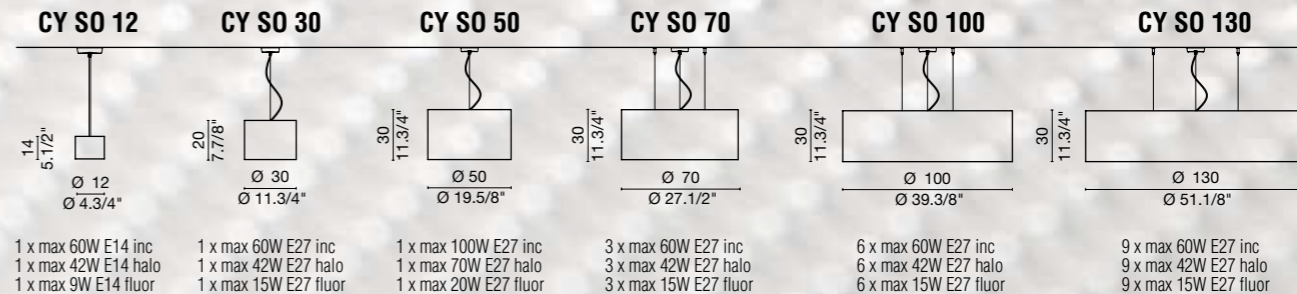

SOSPENSIONE RETTANGOLARE / SUSPENSION RECTANGLE

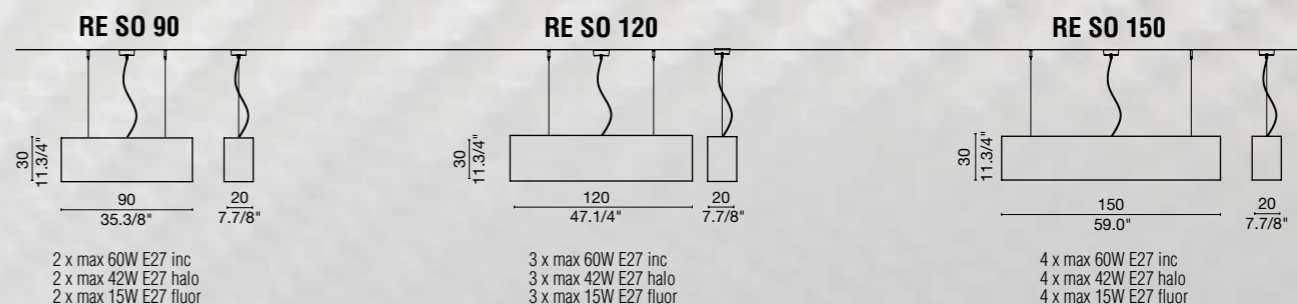

SOSPENSIONE QUADRATO / SUSPENSION SQUARE

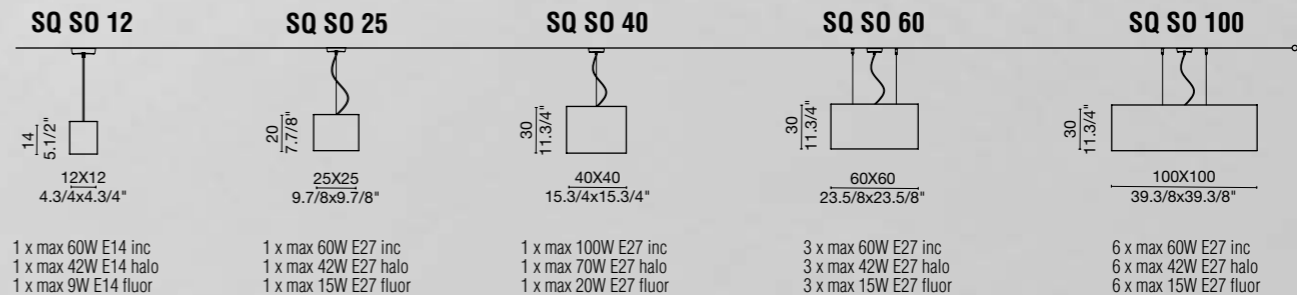



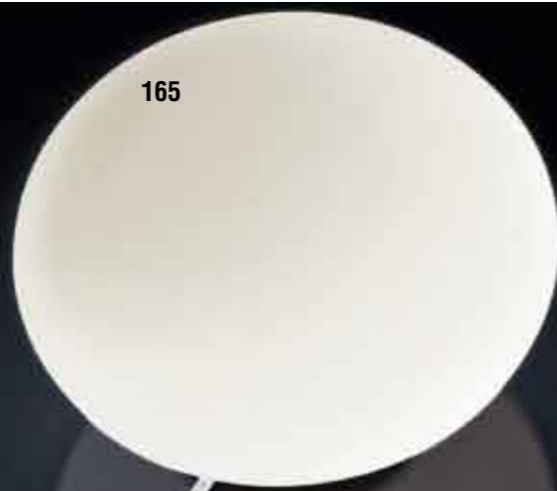





MISTRAL design **L4B**

SO 20

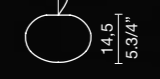

Ø 22
Ø 8.5/8"

1 x max 100W E14 inc
1 x max 11W E14 fluor

SO 35



Ø 35
Ø 13.3/4"

1 x max 150W E27 inc
1 x max 23W E27 fluor

SO 45



Ø 45
Ø 17.3/4"

1 x max 250W E27 halo
1 x max 30W E27 fluor



MISTRAL

design **L4B**

AP/PL 35

AP/PL 45

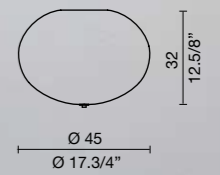
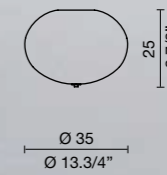

1 x max 150W E27 inc
1 x max 23W E27 fluor

1 x max 250W E27 halo
1 x max 30W E27 fluor

**NET**design **L4B**

Vetro termocurvato con decoro bianco.
Montatura laccata bianca.

Heat-curved glass with white.
Mounting: white enamelled finish.

SO 60

60
23.5/8"

profondità 40
depth 15.3/4"

1 x max 300W R7s 114 mm halo

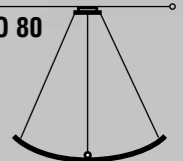
SO 80

80
31.1/2"

profondità 50
depth 19.5/8"

1 x max 300W R7s 114 mm halo



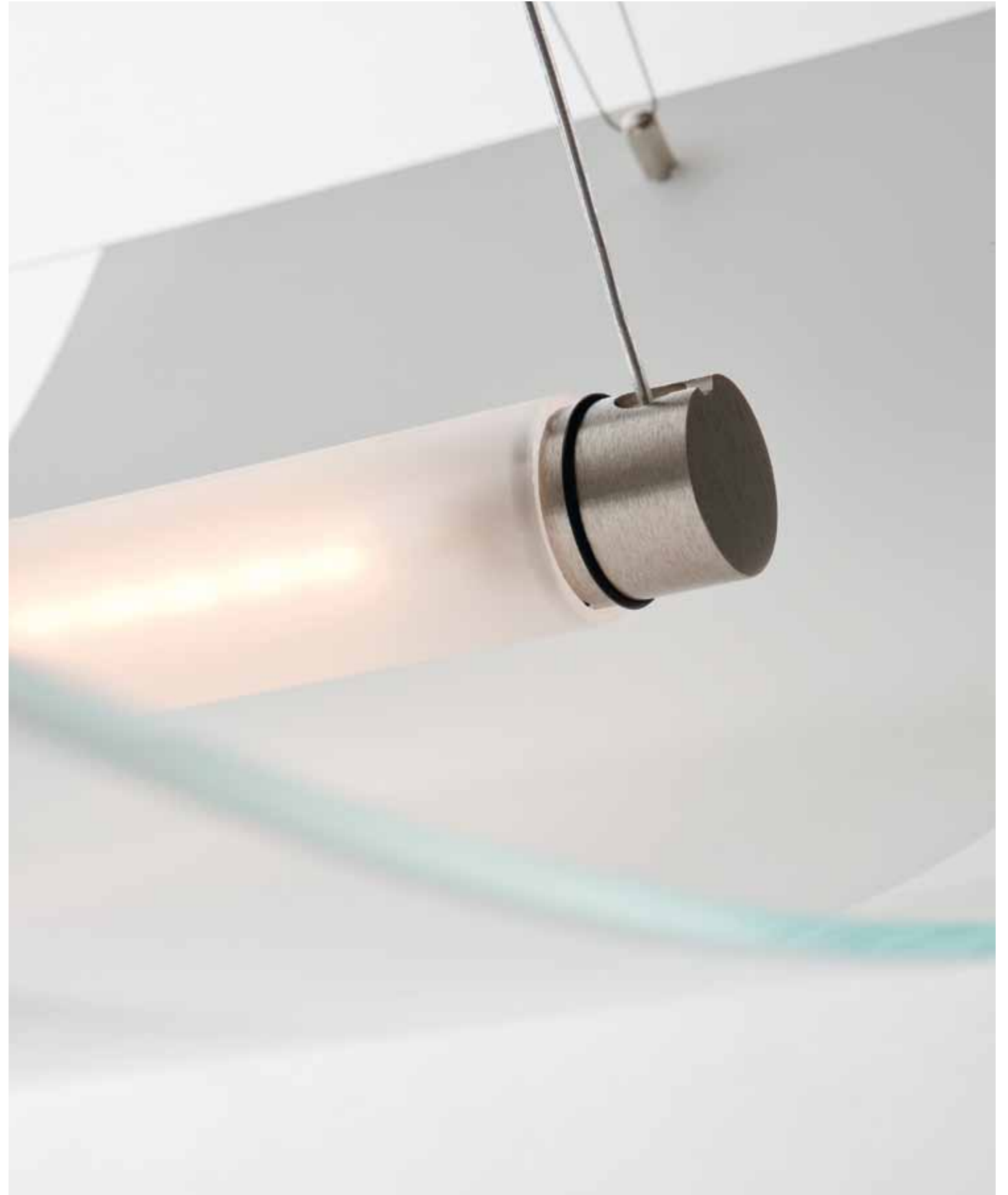

**DROP**design **Brian Rasmussen**

Diffusore inferiore in cristallo temperato sublimato. Diffusore laterale in metacrilato prismatico a doppia rifrazione. Particolare in alluminio tornito e lucidato.

Bottom diffuser in thermal tempered crystal glass. Side diffuser in prismatic methacrylate with double refraction. A detail in polished, lathe-turned aluminium.

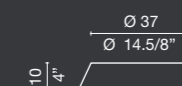
AP/PL 45

Ø 48
Ø 18.7/8"

6 x max 15W E27 fluor

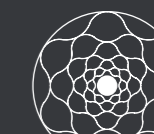
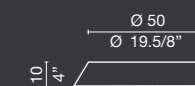
AP/PL 60

Ø 62.5
Ø 24.5/8"

6 x max 23W E27 fluor





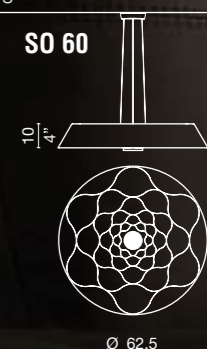

DROP design **Brian Rasmussen**

<p>SO 45</p>  <p>10 1/4" Ø 48 Ø 18.7"</p>	<p>SO 60</p>  <p>10 1/4" Ø 62.5 Ø 24.5"</p>
<p>6 x max 15W E27 fluor</p>	<p>6 x max 23W E27 fluor</p>

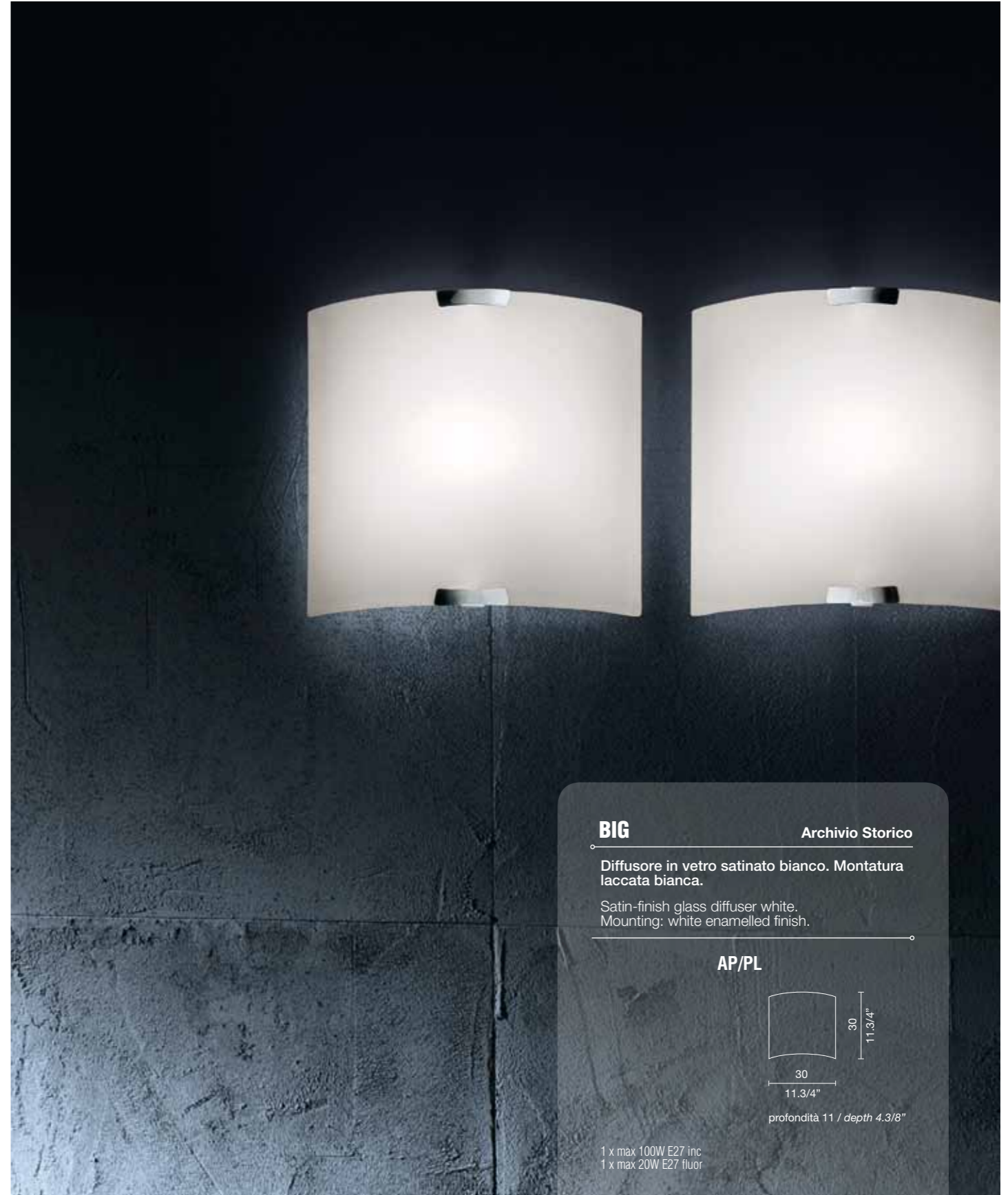
**BIG**

Archivio Storico

Diffusore in vetro satinato bianco. Montatura laccata bianca.

Satin-finish glass diffuser white.
Mounting: white enamelled finish.

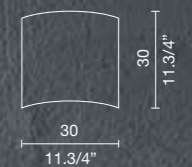
AP/PL

profondità 11 / depth 4.3/8"

1 x max 100W E27 inc
1 x max 20W E27 fluor

**FONTI DI LUCE COME MESSAGGI, UNA CREAZIONE COSTANTE
ILLUMINARE SIGNIFICA LEGGERE GLI SPAZI COME UN**

ON/OFF LIGHT SOURCES ARE MESSAGES THAT CONTINUOUSLY GENERATE LIFE AND THOUGHTS. STYLE AND DYNAMIC APPEAL. ILLUMINATING MEANS READING SPACES LIKE AN OPEN BOOK, INTERPRETING, DREAMING AND PERCEIVING.

**ANTE DI VITA E PENSIERI, ON/OFF. RITMO E DINAMICITÀ.
LIBRO APERTO, INTERPRETARE E SOGNARE, PERCEPIRE.**



MAX

Archivio Storico

Diffusore in vetro bianco incamiciato satinato. Montatura laccata bianca.

White satin-finish 'incamiciato' glass diffuser. Mounting: white enamelled finish.

AP 22

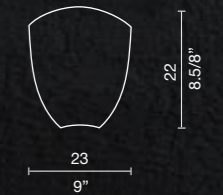

1 x max 100W E27 inc
1 x max 15W E27 fluor

profondità 11
depth 4.3/8"

**ONDA**

Archivio Storico

Vetro incamiciato bianco lucido
Montatura cromo lucido.

White 'incamiciato' polished glass
Mounting chromed.

S0

1 x max 150W E27 inc
1 x max 23W E27 fluor

**ANGEL**design **L4B**

Diffusore in vetro soffiato bianco lucido con morisa in cristallo lavorata a mano, applicata a caldo. Montatura cromata.

Blown glass diffuser with crystal "morisa" decoration shaped by hand and heat-worked available in shiny white. Mounting chromed.

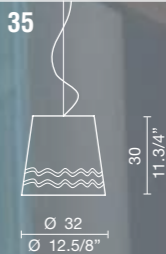
SO 35

1 x max 150W E27 inc
1 x max 23W E27 fluor

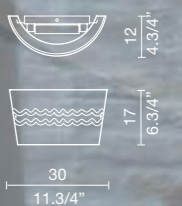
AP

1 x max 150W R7s 114 mm halo
1 x max 100W E27 inc
1 x max 15W E27 fluor



ANGEL

design **L4B**

SO 40

SO 70

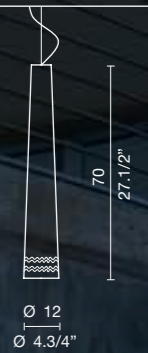
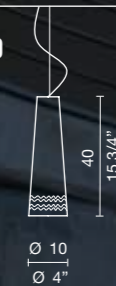

1 x max 100W E27 inc
1 x max 15W E27 fluor

1 x max 150W E27 inc
1 x max 20W E27 fluor



ANGEL

design **L4B**

PL 40

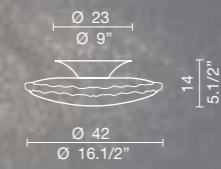

2 x max 60W E27 inc
2 x max 15W E27 fluo

PL 50

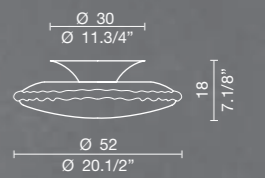

2 x max 75W E27 inc
2 x max 20W E27 fluo

**PASHA'**design **L4B**

Diffusore in vetro soffiato bianco/bianco, nero/bianco, nero/rosso o "balloton" specchiato. Montatura cromo lucido.

Shiny white/white, black/white, black/red or mirror finish "balloton style". Mounting shiny chrome.

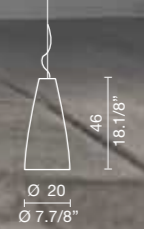
SO 45

1 x max 150W E27 inc
1 x max 23W E27 fluor

SO 60

1 x max 150W E27 inc
1 x max 23W E27 fluor



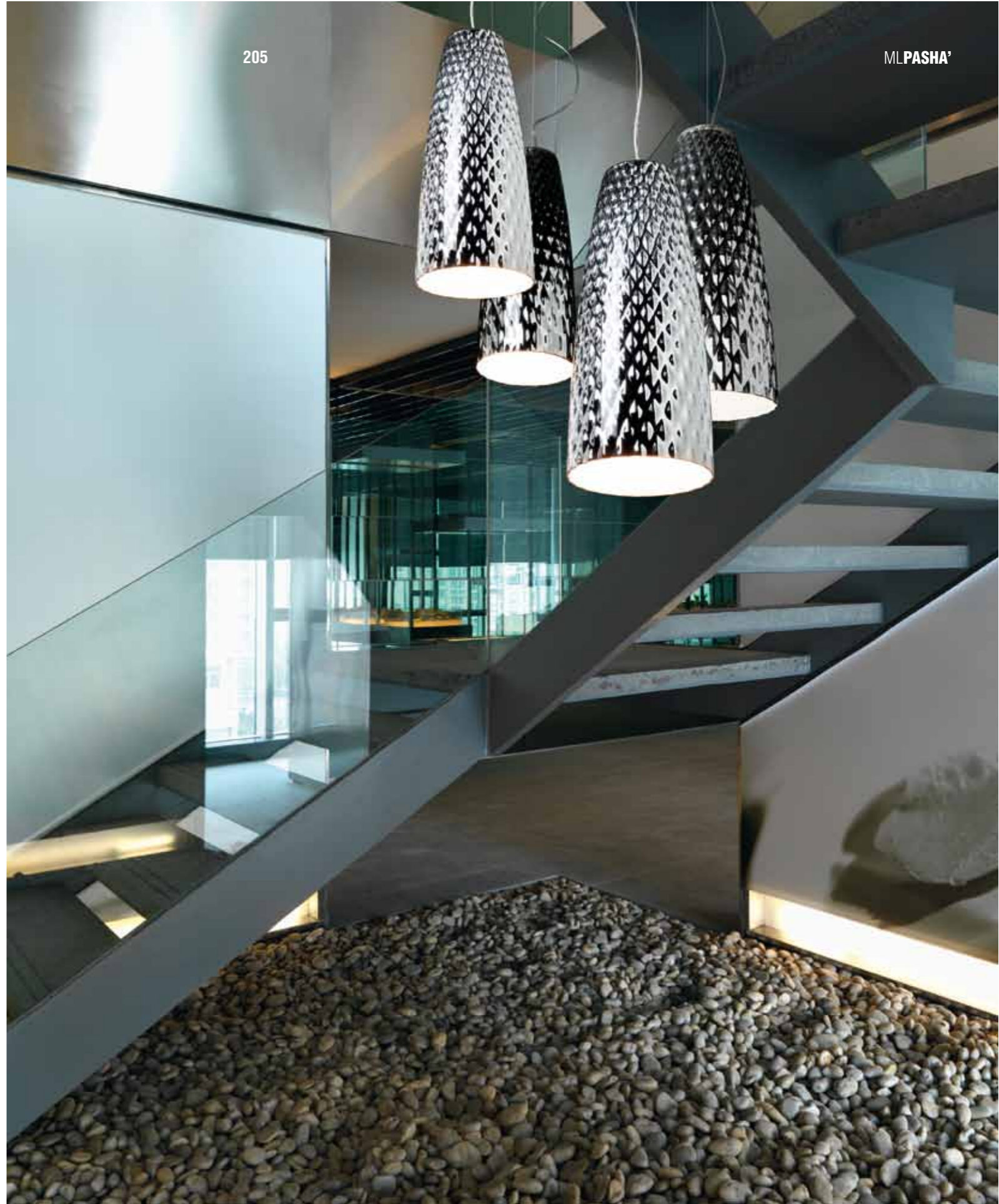



FADE design **Brian Rasmussen**

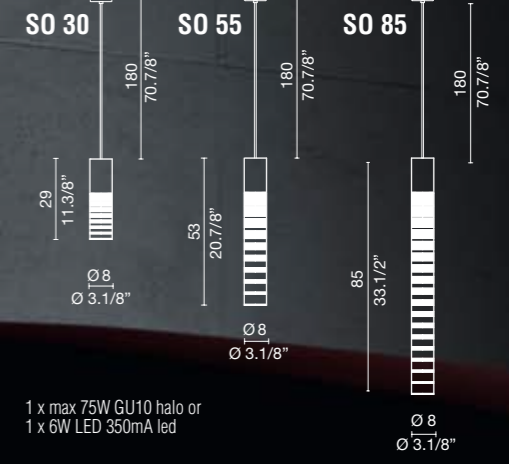

1 x max 75W GU10 halo or
1 x 6W LED 350mA led







**FADE**design **Brian Rasmussen**

Lampada tecnica con montatura in alluminio ricavato dal pieno e verniciato bianco opaco. Diffusore in vetro borosilicato con decoro sabbiato.

A technical lamp comprising an aluminium billet fixture with matt white lacquer finish. Borosilicate glass diffuser with sandblasted decoration.

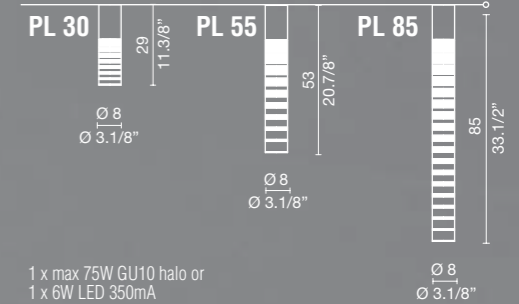



FADE design **Brian Rasmussen**

	AP 25	AP 50
Height	25 9.778"	49 19.14"
Width	9 3.12"	9 3.12"
Depth	9 3.12"	13 5.18"
Lighting	1 x max 75W GU10 halo or 1 x 6W LED 350mA	1 x max 75W GU10 halo or 1 x 6W LED 350mA



220

221

MLDOUBLE



DOUBLE

Archivio Storico

S0

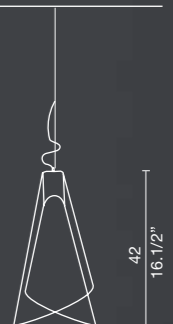

1 x max 100W E27 inc
1 x max 21W E27 fluor

Ø 26
Ø 1.014"



**DOUBLE**

Archivio Storico

Vetro soffiato cristallo trasparente con
diffusore interno in vetro bianco.
Montatura nickel satinato.

Clear crystal blown glass with inside white glass
diffuser. Mounting: polished nickel.

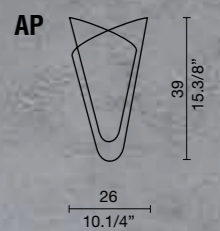

1 x max 100W E27 inc
1 x max 15W E27 fluor

profondità 12
depth 4.3/4"



**ALIAS**design **L4B**

Diffusore in vetro soffiato con decoro molato realizzato a mano libera nei colori crema, testa di moro e bianco. Montatura laccata bianca opaca.

Blown glass diffuser with decoration engraved by hand in the following colours: cream, dark brown and white. Mounting: white enameled matte finish.

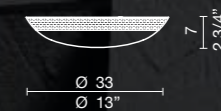
AP/PL 35

2 x max 60W E27 inc
2 x max 7W E27 fluo

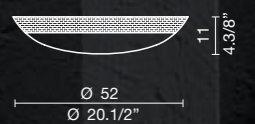
AP/PL 55

3 x max 60W E27 inc
3 x max 15W E27 fluo



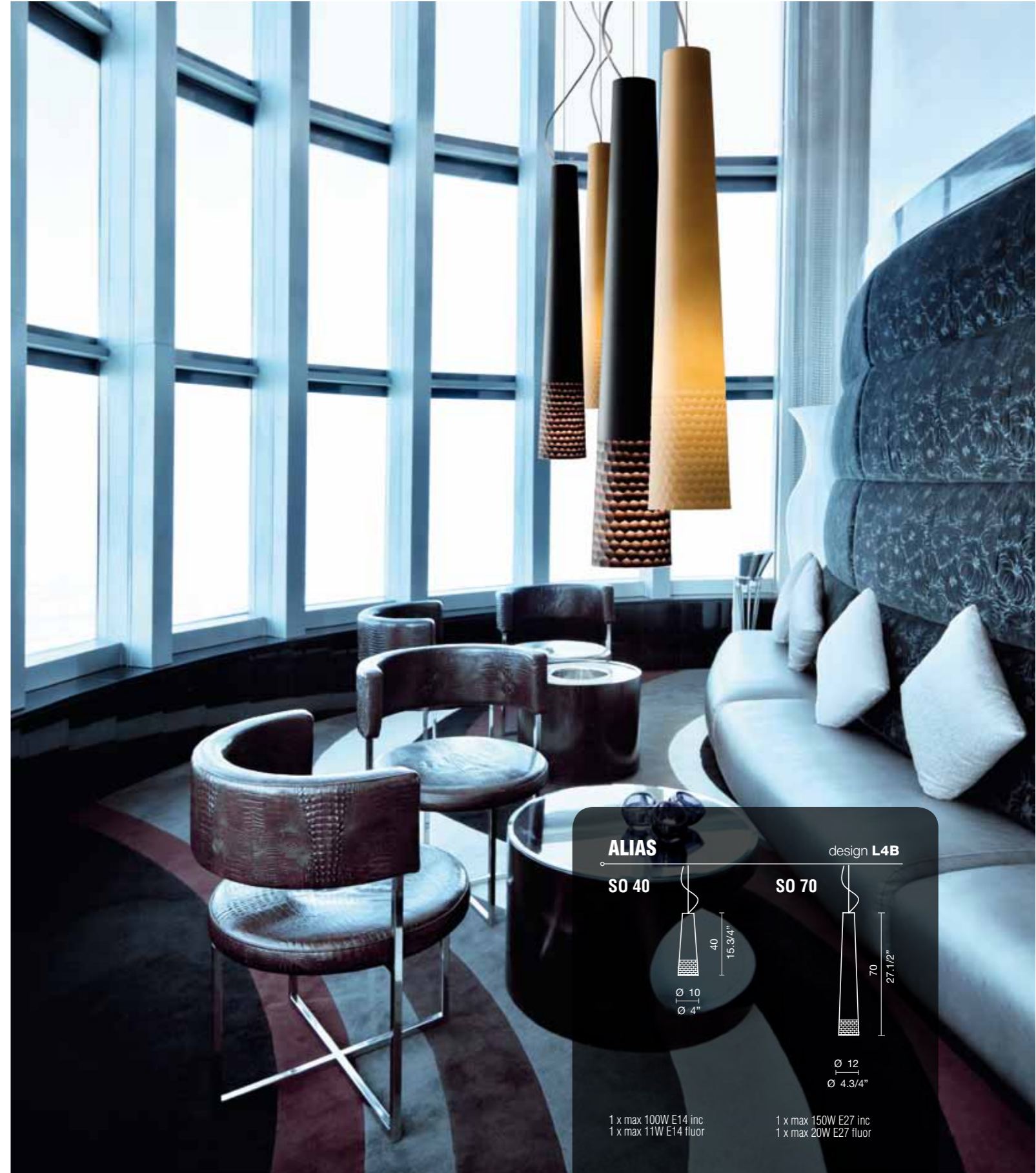

ALIAS

design **L4B**

SO 40

SO 70

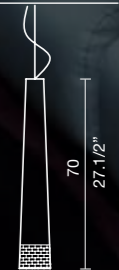

1 x max 100W E14 inc
1 x max 11W E14 floor

1 x max 150W E27 inc
1 x max 20W E27 floor

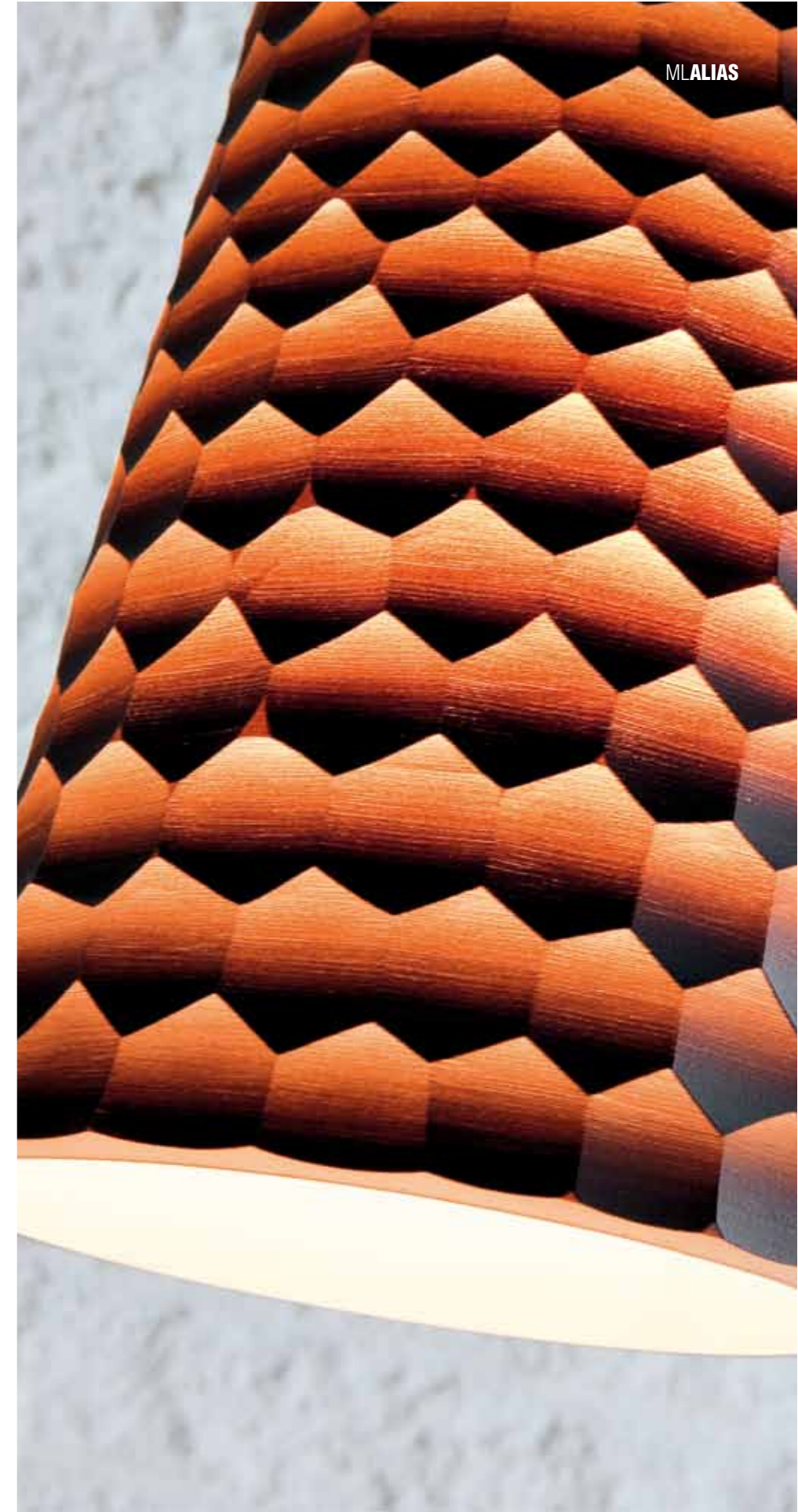

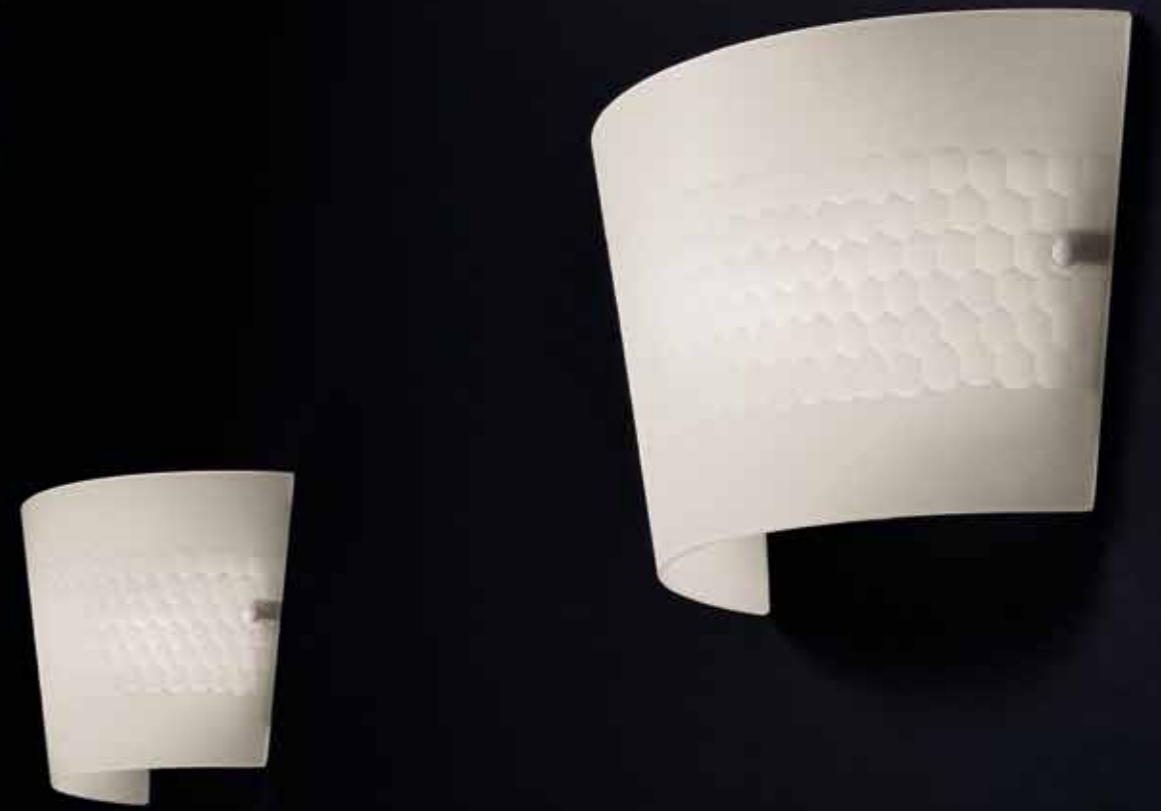

ALIAS

design **L4B**

AP



profondità 12 / depth 4.3/4"

1 x max 100W E27 inc
1 x max 15W E27 fluor



CANDIDA

Archivio Storico

SO 50

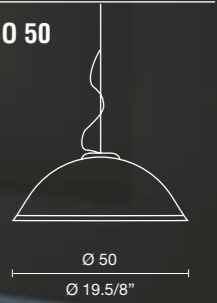

1 x max 150W E27 inc
1 x max 23W E27 fluor



CANDIDA

Archivio Storico

Vetro soffiato incamiciato bianco satinato.
Montatura laccata bianca.

White satin-finish 'incamiciato' blown glass.
Mounting: white enamelled finish.

AP/PL 30



Ø 32
Ø 12.5/8"

profondità 12
depth 4.3/4"

1 x max 75W E27 inc
1 x max 20W E27 fluor

AP/PL 40



Ø 42
Ø 16.1/2"

profondità 14
depth 5.1/2"

1 x max 100W E27 inc
1 x max 23W E27 fluor

AP/PL 50



Ø 52
Ø 20.1/2"

profondità 15
depth 5.7/8"

2 x max 75W E27 inc
2 x max 23W E27 fluor

**OVO**

Archivio Storico

Vetro bianco incamiciato a finitura satinata.
Montatura laccata bianca.

White satin-finish incamiciato glass.
Mounting: white enameled finish.

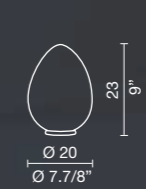
TA 20

1 x max 60W E14 inc
1 x max 14W E14 fluor

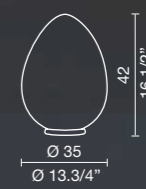
TA 40

1 x max 100W E27 inc
1 x max 23W E27 fluor

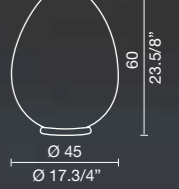
TA 60

1 x max 150W E27 inc
1 x max 30W E27 fluor



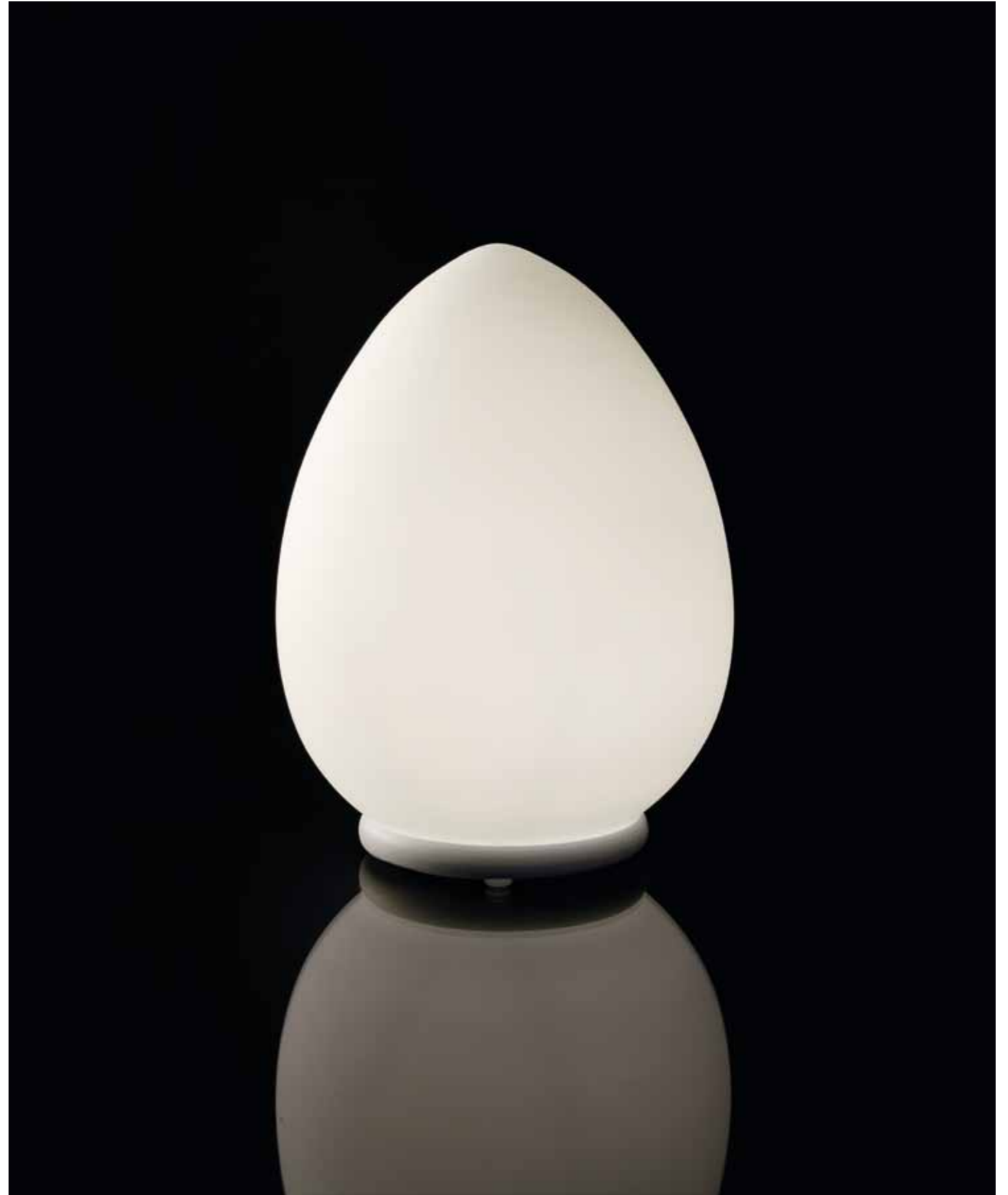

La riproduzione in qualsiasi formato di questo catalogo o di parte di esso è assolutamente proibita senza la previa autorizzazione scritta di Light4 srl. Il logo ML (Muranoluce) è di esclusiva titolarità e proprietà di Light4 srl. Non può essere riprodotto né usato per scopi commerciali, senza il consenso scritto di Light4 srl. L'azienda si riserva di modificare, in qualsiasi momento e senza nessun preavviso, le caratteristiche tecniche dei prodotti illustrati in questo catalogo. Light4 srl declina inoltre ogni responsabilità per eventuali errori di stampa presenti nel catalogo. I materiali scelti e la componentistica elettrica sono di prima qualità. Assemblaggio e controllo vengono eseguiti in maniera rigorosa da manodopera specializzata. La produzione in vetro soffiato può presentare alcune minime differenze di peso, colore o spessore, dovute alla lavorazione artigianale dei pezzi. Le eventuali bolle e irregolarità presenti nell'impasto non sono infatti difetti di lavorazione ma caratteristiche preziose ed uniche del vetro soffiato a mano o lavorato artigianalmente. Ogni corpo illuminante è corredato con una busta contenente un foglio di istruzioni, garanzia e modalità di assemblaggio. Light4 srl declina ogni responsabilità per modifiche o riparazioni non autorizzate effettuate dopo l'acquisto, o per mancato rispetto delle istruzioni di montaggio. Tali azioni possono infatti compromettere la sicurezza del prodotto e provocare situazioni di pericolo per l'utente. Tutti gli apparecchi di illuminazione presenti in questo catalogo sono stati progettati e costruiti in conformità alle normative italiane CEI 34-21 armonizzate con le europee EN 60598-1 che a loro volta recepiscono le normative internazionali IEC 58-1. Le dimensioni riportate nei disegni tecnici dei prodotti sono espresse in cm. Salvo diverse indicazioni gli apparecchi sono forniti senza lampadine.

I prodotti ML (Muranoluce) by Light4 srl sono modelli depositati.

Reproduction of this catalogue or part there of, adopting any format, is strictly prohibited without the prior written consent of Light4 srl. Light4 srl has exclusive ownership of and title to the logo ML (Muranoluce). It cannot be reproduced or used for trading purposes without the written consent of Light4 srl. The company reserves the right to modify the technical characteristics of the products illustrated in this catalogue at any time without any prior notice. Furthermore Light4 srl does not accept liability for any printing errors found in this catalogue. The materials selected and the electrical parts are of the finest quality. Assembly and controls are dealt with by specialised staff to rigorous standards. Items produced in blown glass may vary slightly in weight, colour or thickness, seeing that Light4 srl articles are worked by hand. Any air bubbles or irregularities in the mix are not in fact production defects, but represent the precious and unique characteristics of glass that is blown by hand or worked by craftsmen. Each light is supplied with a bag containing the instructions sheet, warranty and assembly instructions. Any unauthorised modifications and/or repairs of any type made to the product after purchase or failure to follow the assembly instructions may affect the safety of the product and create a hazard for those using it. Light4 srl does not therefore accept any liability in such circumstances. All the lighting equipment illustrated in this catalogue have been designed in conformity to Italian CEI standards 34-21, brought into line with European standards EN 60598-1 which in turn implement international standards IEC 58-1. The measurements given in the technical drawings of the products are expressed cm. Unless otherwise indicated, the articles are supplied without light bulbs.

The ML (Muranoluce) by Light4 srl products are all registered models.

LIGHT4

LIGHT4 srl Viale dell'Industria, 2A
31055 Quinto di Treviso (tv) - ITALIA
t. +39 0422 475009 / 378122
f +39 0422 370409
www.light4.it - info@light4.it

print
ARBE _ MO

fotolito
GM STUDIO1 _ VR

photo e concept
IDP DESIGN&COMMUNICATION _ TV

